

ULINE H-6893BLU

OPEN GEAR LOCKER – BLUE

1-800-295-5510
 uline.com

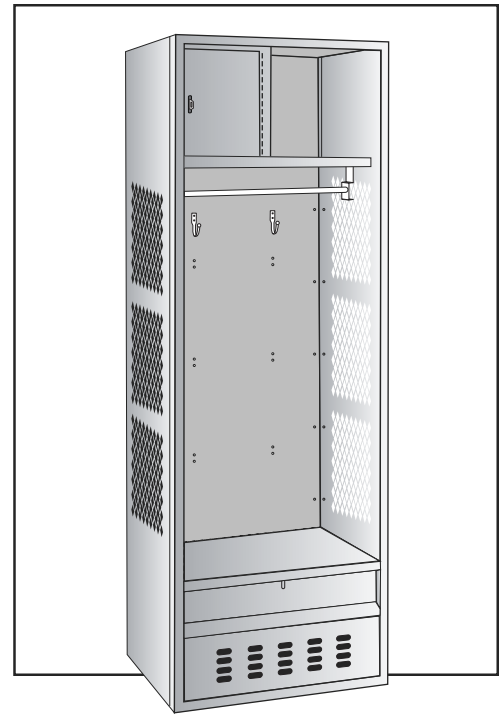
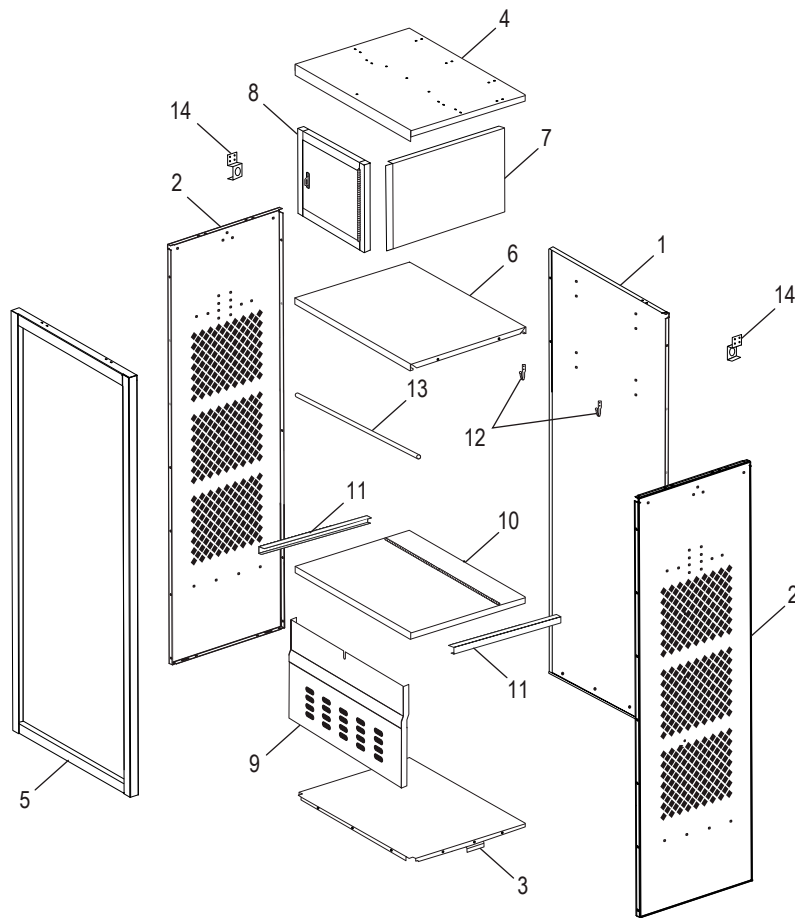

#	DESCRIPTION	QTY.	ULINE PART NO.	MFG. PART NO.
1	Back	1	-----	11-242472-BLUE
2	Side	2	-----	018-141872-BLUE
3	Bottom	1	-----	11-452418-BLUE
4	Top	1	-----	11-442418-BLUE
5	Frame	1	-----	11-642472-BLUE
6	Upper Shelf	1	-----	11-342415-BLUE
7	Upper Shelf Divider	1	-----	11-141512-BLUE
8	Upper Cabinet Door	1	-----	018-041212-BLUE
9	Foot Locker Front	1	-----	018-342414-BLUE
10	Foot Locker Cover	1	-----	11-342418-BLUE
11	Foot Locker Rail	2	-----	11-340118/340218-BLUE
12	Coat Hook	2	-----	11-902001
13	Coat Rod	1	-----	11-901024
14	Coat Rod Bracket	2	-----	11-951000
	Hardware Kit (Not Shown) Includes: • Bolts (105) • Nuts (105)	1	H-6895	-----

ULINE H-6893BLU
LOCKER SIN PUERTAS
PARA EQUIPO – AZUL

800-295-5510
 uline.mx

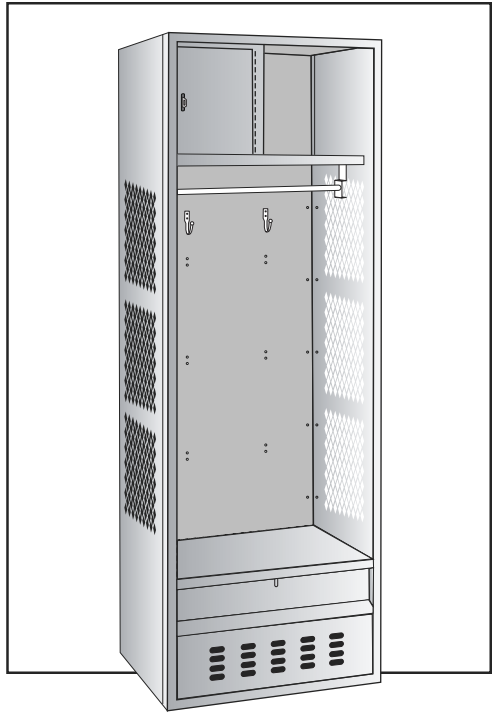
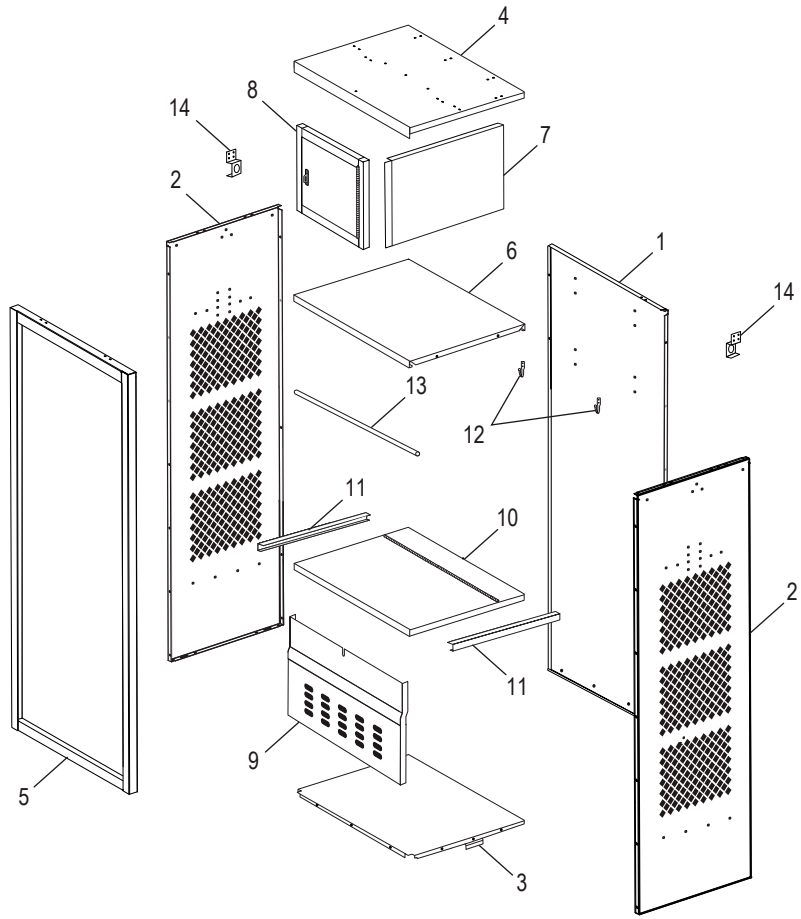

#	DESCRIPCIÓN	CANT.	NO. DE PARTE DE ULINE	NO. DE PARTE DEL FABRICANTE
1	Parte Posterior	1	-----	11-242472-BLUE
2	Lateral	2	-----	018-141872-BLUE
3	Parte Inferior	1	-----	11-452418-BLUE
4	Parte Superior	1	-----	11-442418-BLUE
5	Armazón	1	-----	11-642472-BLUE
6	Repisa Superior	1	-----	11-342415-BLUE
7	Divisor de Repisa Superior	1	-----	11-141512-BLUE
8	Puerta de Gabinete Superior	1	-----	018-041212-BLUE
9	Frente del Cajón Inferior	1	-----	018-342414-BLUE
10	Cubierta del Cajón Inferior	1	-----	11-342418-BLUE
11	Riel para el Cajón Inferior	2	-----	11-340118/340218-BLUE
12	Gancho para Chamarras	2	-----	11-902001
13	Barra para Chamarras	1	-----	11-901024
14	Soporte de Barra para Chamarras	2	-----	11-951000
	Kit de Tornillería (No se Muestra) Incluye: • Pernos (105) • Tuercas (105)	1	H-6895	-----

ULINE H-6893BLU
CASIER À ÉQUIPEMENT
OUVERT – BLEU

1-800-295-5510
 uline.ca

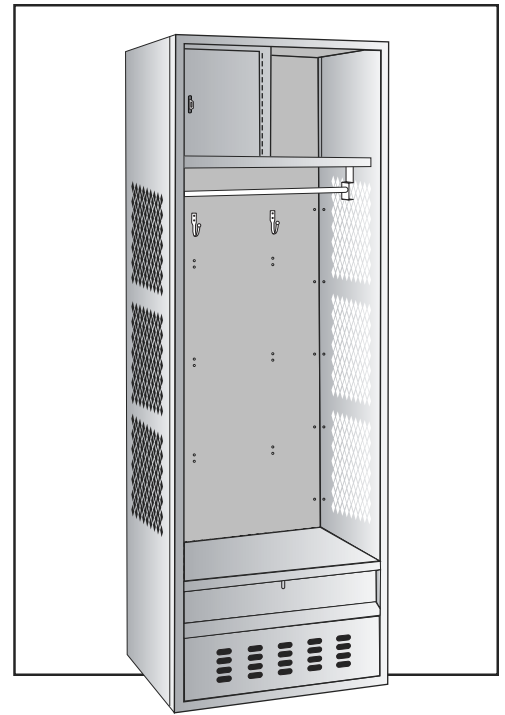
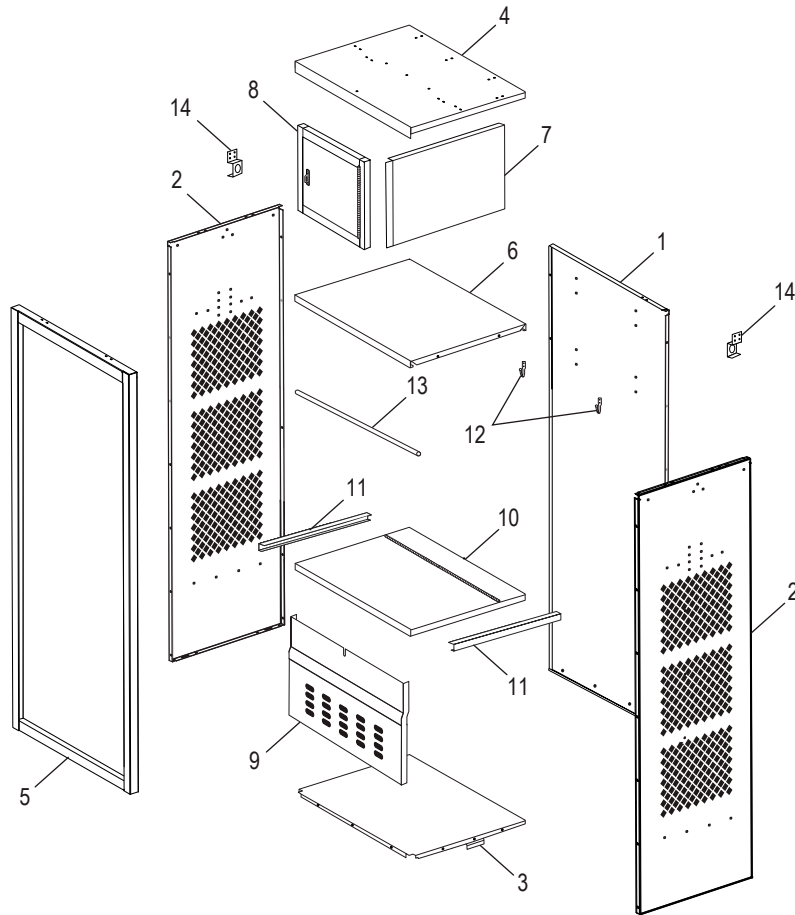

#	DESCRIPTION	QTÉ	RÉF. ULINE	RÉF. DU FABRICANT
1	Arrière	1	-----	11-242472-BLUE
2	Côté	2	-----	018-141872-BLUE
3	Bas	1	-----	11-452418-BLUE
4	Dessus	1	-----	11-442418-BLUE
5	Cadre	1	-----	11-642472-BLUE
6	Tablette supérieure	1	-----	11-342415-BLUE
7	Séparateur de tablette supérieure	1	-----	11-141512-BLUE
8	Porte de casier supérieur	1	-----	018-041212-BLUE
9	Avant du casier pour chaussures	1	-----	018-342414-BLUE
10	Couvercle du casier pour chaussures	1	-----	11-342418-BLUE
11	Rail de guidage du casier pour chaussures	2	-----	11-340118/340218-BLUE
12	Patère	2	-----	11-902001
13	Tringle	1	-----	11-901024
14	Support à tringle	2	-----	11-951000
	L'ensemble de quincaillerie (non illustrés) Comprend : • Boulons (105) • Écrous (105)	1	H-6895	-----