

ULINE H-6844
DELUXE WORKSTATION –
48 x 36"

1-800-295-5510
 uline.com

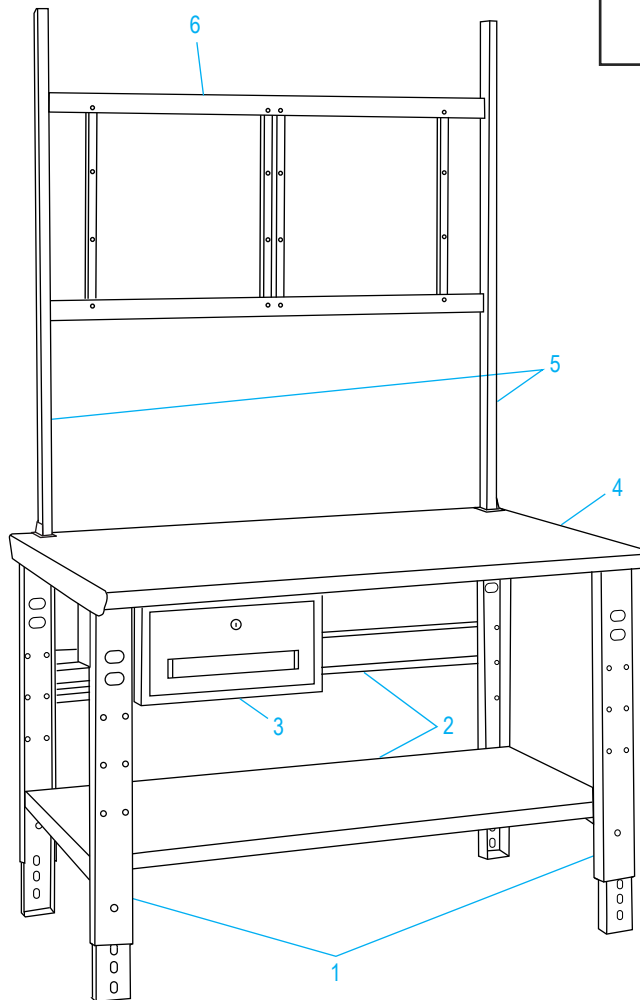
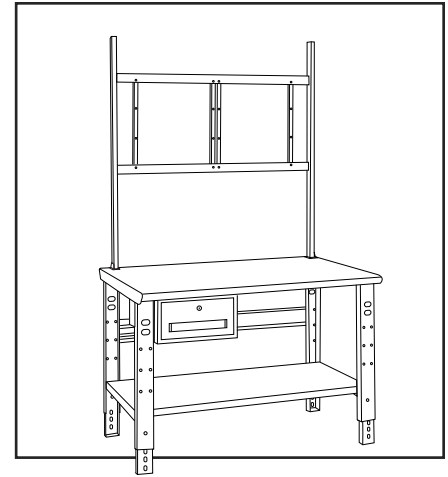

#	DESCRIPTION	QTY.	ULINE PART NO.	MFG. PART NO.
1	Packing Table Legs	2	H-1136LEG	AL-3236-2
2	Full Shelf and Stringer	1	H-6846	FS-4836/WBS-48
3	Packing Table Drawer	1	H-1550	WBD-1L
4	Wood Packing Table Top	1	H-3657-TOP	-----
4	Laminate Packing Table Top	1	H-3657-LTOP	-----
4	Maple Packing Table Top	1	H-3657-MTOP	-----
5	Uprights	2	H-5777	H-5777
6	Panel Mounting Kit	1	H-6850	H-6850

ULINE H-6844

**ESTACIÓN DE TRABAJO
DE ALTA CALIDAD –
48 x 36"**

800-295-5510
uline.mx

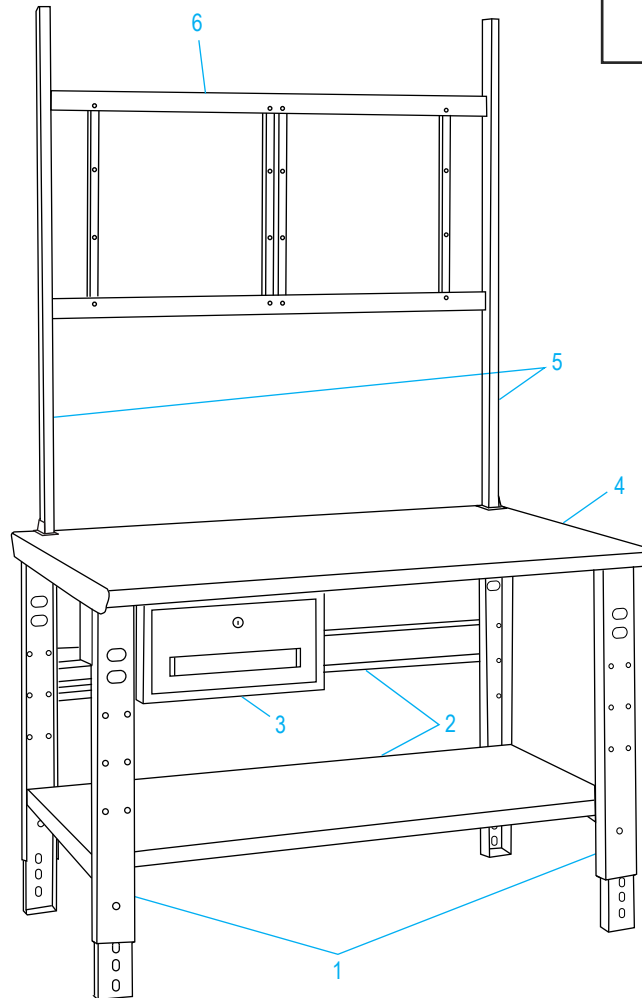
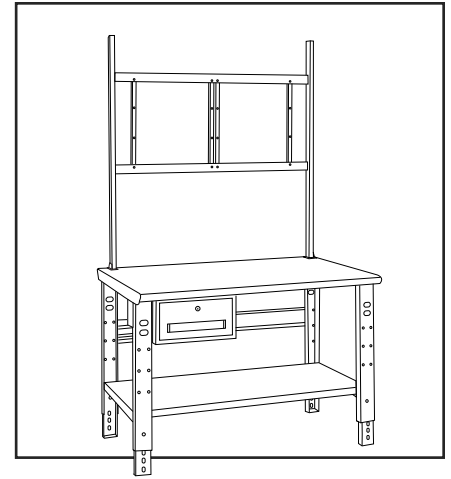

#	DESCRIPCIÓN	CANT.	NO. DE PARTE DE ULINE	NO. DE PARTE DEL FABRICANTE
1	Patas de la Mesa	2	H-1136LEG	AL-3236-2
2	Repisa Completa y Larguero	1	H-6846	FS-4836/WBS-48
3	Cajón de la Mesa de Trabajo	1	H-1550	WBD-1L
4	Cubierta de Madera	1	H-3657-TOP	-----
4	Cubierta de Plástico Laminado	1	H-3657-LTOP	-----
4	Cubierta de Arce	1	H-3657-MTOP	-----
5	Postes	2	H-5777	H-5777
6	Kit de Instalación del Panel	1	H-6850	H-6850

ULINE H-6844
POSTE DE TRAVAIL
DE LUXE – 48 x 36 PO

1-800-295-5510
 uline.ca

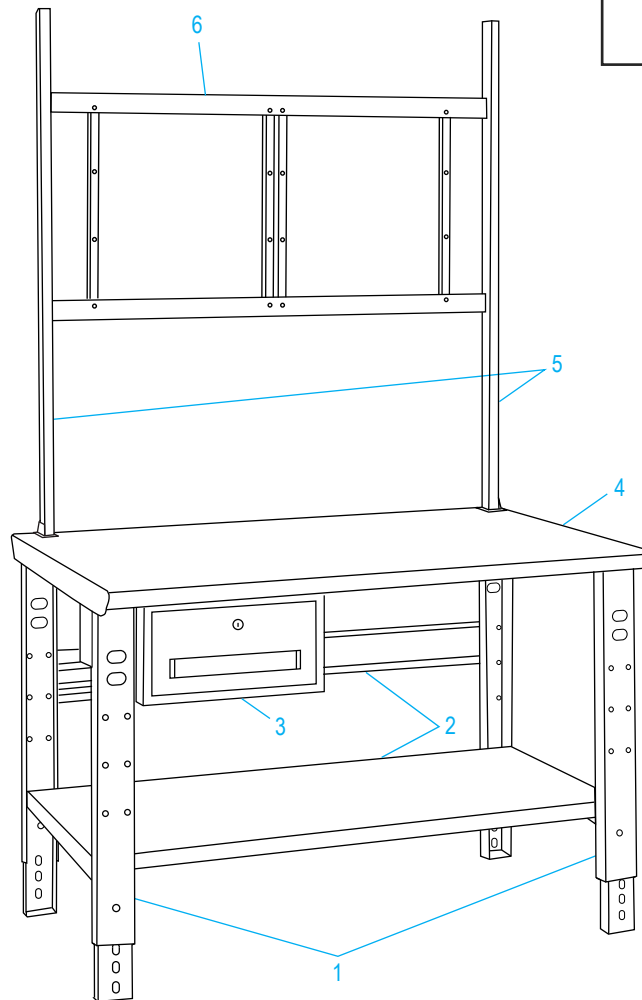
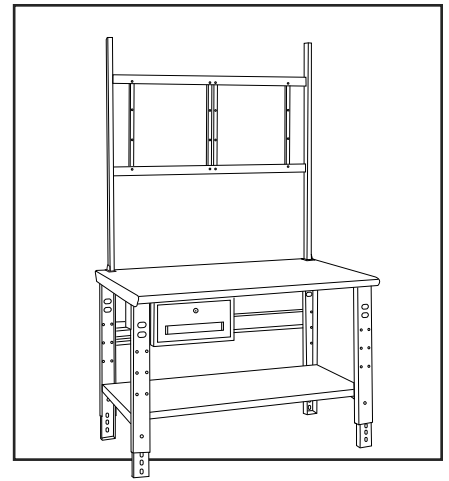

#	DESCRIPTION	QTÉ	RÉF. ULINE	RÉF. DU FABRICANT
1	Pattes de table d'emballage	2	H-1136LEG	AL-3236-2
2	Tablette intégrale et longeron	1	H-6846	FS-4836/WBS-48
3	Tiroir de table d'emballage	1	H-1550	WBD-1L
4	Surface de table d'emballage en bois	1	H-3657-TOP	-----
4	Surface de table d'emballage stratifiée	1	H-3657-LTOP	-----
4	Surface de table d'emballage en érable	1	H-3657-MTOP	-----
5	Montants	2	H-5777	H-5777
6	Matériel d'installation pour panneau	1	H-6850	H-6850