

ULINE

H-1471, H-1472
H-2803

**3M™ 6000 SERIES
FULL-FACE REUSABLE
RESPIRATORS**

1-800-295-5510
uline.com

Para Español, vea páginas 3-4.
Pour le français, consulter les pages 5-6.

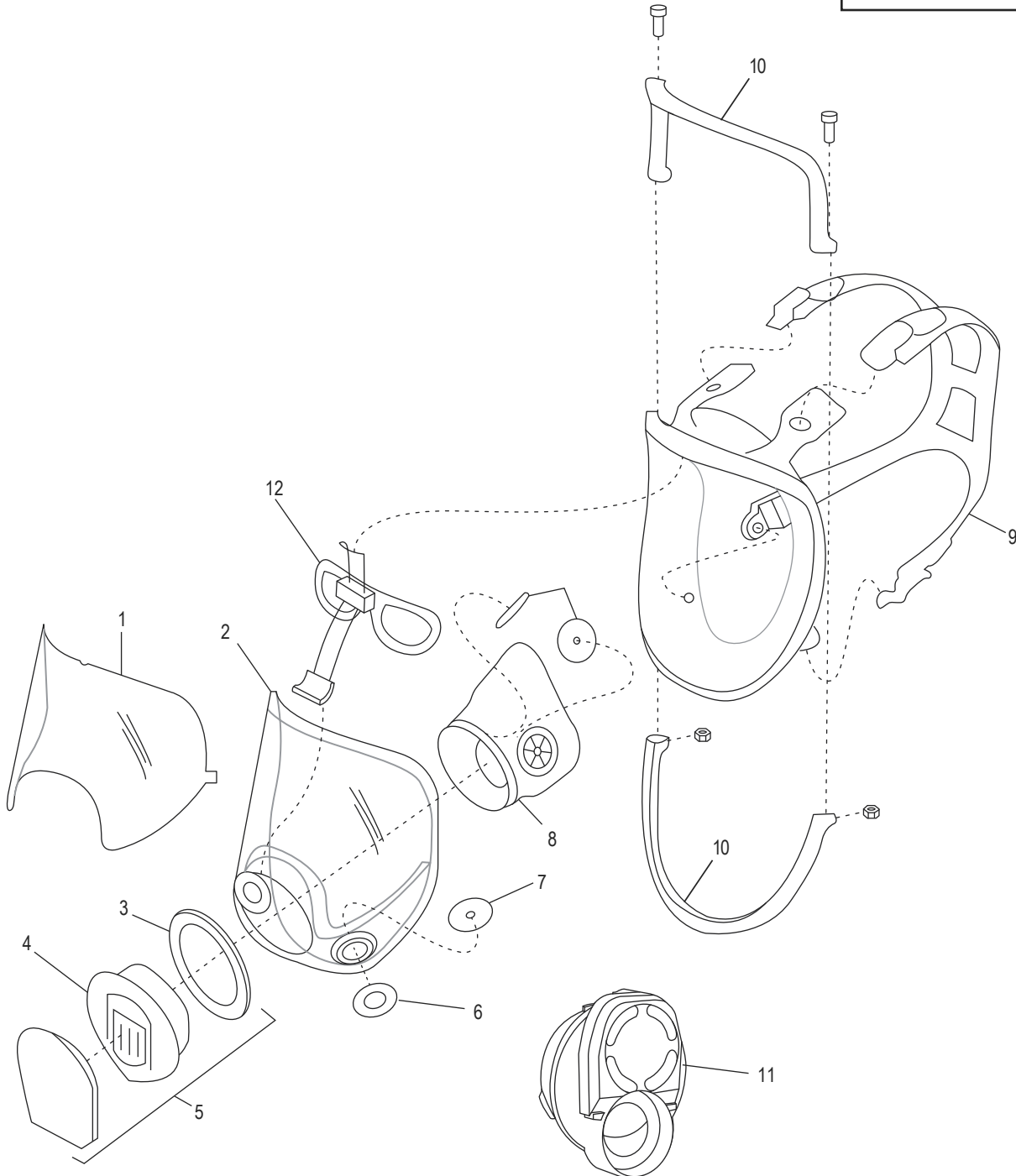
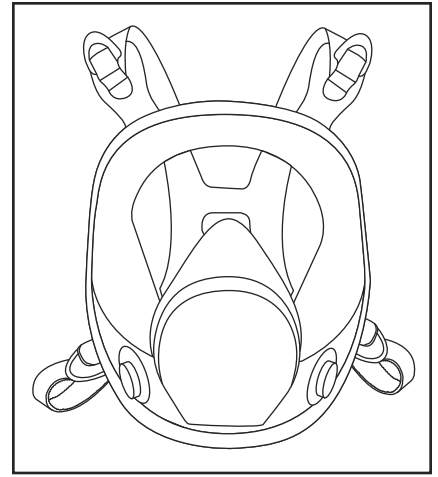



H-1471, H-1472
H-2803

1-800-295-5510
uline.com

3M™ 6000 SERIES FULL-FACE REUSABLE RESPIRATORS

PARTS DIAGRAM

#	DESCRIPTION	QTY.	ULINE PART NO.	MFG. PART NO.	3M NO.
1	Face Shield Cover (Clear)	1	S-16201	7100138628	6885
2	Lens Assembly	1	H-1472-6898	7000002036	6898
3	Adapter Gasket	1	H-1472-6896	7000052122	6896
4	Exhalation Valve	1	H-1472-7583	7000002159	7583
5	Center Adapter Assembly	1	-----	7000002178	6864
6	Inhalation Gasket	2	H-1472-GASKT	7000002050	6895
7	Inhalation Valve	2	H-1472-6893	7000002049	6893
8	Nose Cup	1	H-1472-6894	7000002034	6894
9	Head Harness Assembly	1	H-1471-STRAP	7000002035	6897
10	Frame Kit	1	-----	7100001832	6899
11	DIN	1	-----	7000002032	6884

ACCESSORIES (NOT INCLUDED)

#	DESCRIPTION	QTY.	ULINE PART NO.	MFG. PART NO.	3M NO.
12	Spectacle Kit	1	S-20874	7000002031	6878
	Bayonet Cap (10/Pack)	1	-----	7100006233	6880
	Tinted Lens Cover (25/pack)	1	S-22979	7000052088	6886
	Neck Strap	1	-----	7000125977	7883

ULINE

H-1471, H-1472
H-2803

**3M™ SERIES 6000 –
RESPIRADORES REUTILIZABLES
DE CARA COMPLETA**

800-295-5510
uline.mx

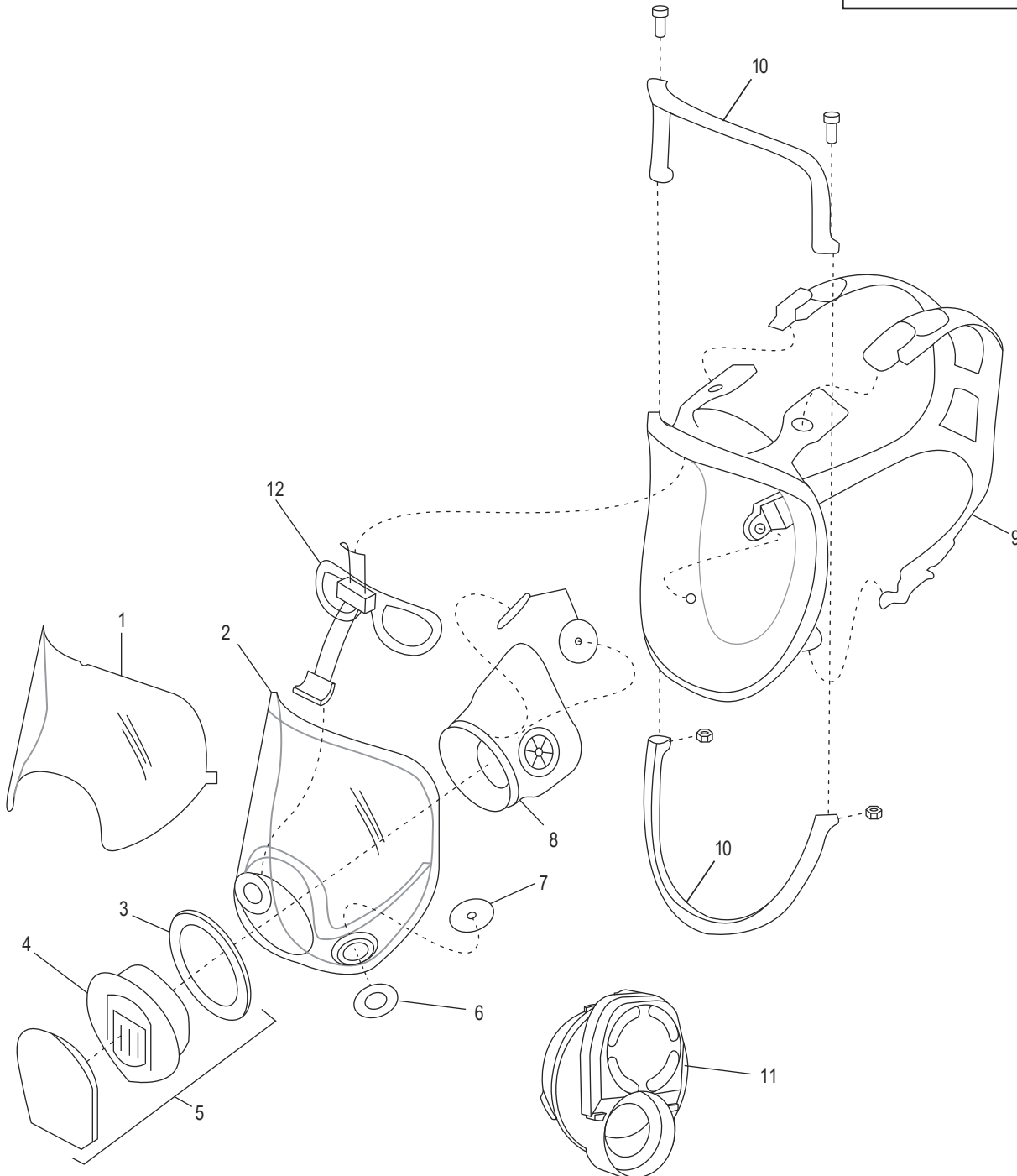
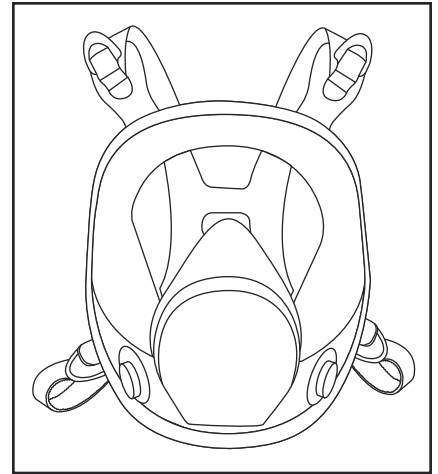



H-1471, H-1472
H-2803

800-295-5510
uline.mx

3M™ SERIES 6000 – RESPIRADORES REUTILIZABLES DE CARA COMPLETA

DIAGRAMA DE PARTES

#	DESCRIPCIÓN	CANT.	NO. DE PARTE DE ULINE	NO. DE PARTE DEL FABRICANTE	NO. DE 3M
1	Cubierta de la Careta (Transparente)	1	S-16201	7100138628	6885
2	Kit de Lentes	1	H-1472-6898	7000002036	6898
3	Empaque de Adaptador	1	H-1472-6896	7000052122	6896
4	Válvula de Exhalación	1	H-1472-7583	7000002159	7583
5	Ensamble Central del Adaptador	1	-----	7000002178	6864
6	Empaque de Inhalación	2	H-1472-GASKT	7000002050	6895
7	Válvula de Inhalación	2	H-1472-6893	7000002049	6893
8	Cubierta para la Nariz	1	H-1472-6894	7000002034	6894
9	Ensamble del Arnés de la Cabeza	1	H-1471-STRAP	7000002035	6897
10	Kit del Armazón	1	-----	7100001832	6899
11	DIN	1	-----	7000002032	6884

ACCESORIOS (NO INCLUIDOS)

#	DESCRIPCIÓN	CANT.	NO. DE PARTE DE ULINE	NO. DE PARTE DEL FABRICANTE	NO. DE 3M
12	Kit para Lentes	1	S-20874	7000002031	6878
	Tapa de Bayoneta (10/Paquete)	1	-----	7100006233	6880
	Cubierta para Lentes Polarizados (25/Paquete)	1	S-22979	7000052088	6886
	Correa de Cuello	1	-----	7000125977	7883

ULINE

H-1471, H-1472
H-2803

1-800-295-5510
uline.ca

**3M™ 6000 –
RESPIRATEUR À MASQUE
COMPLET RÉUTILISABLE**

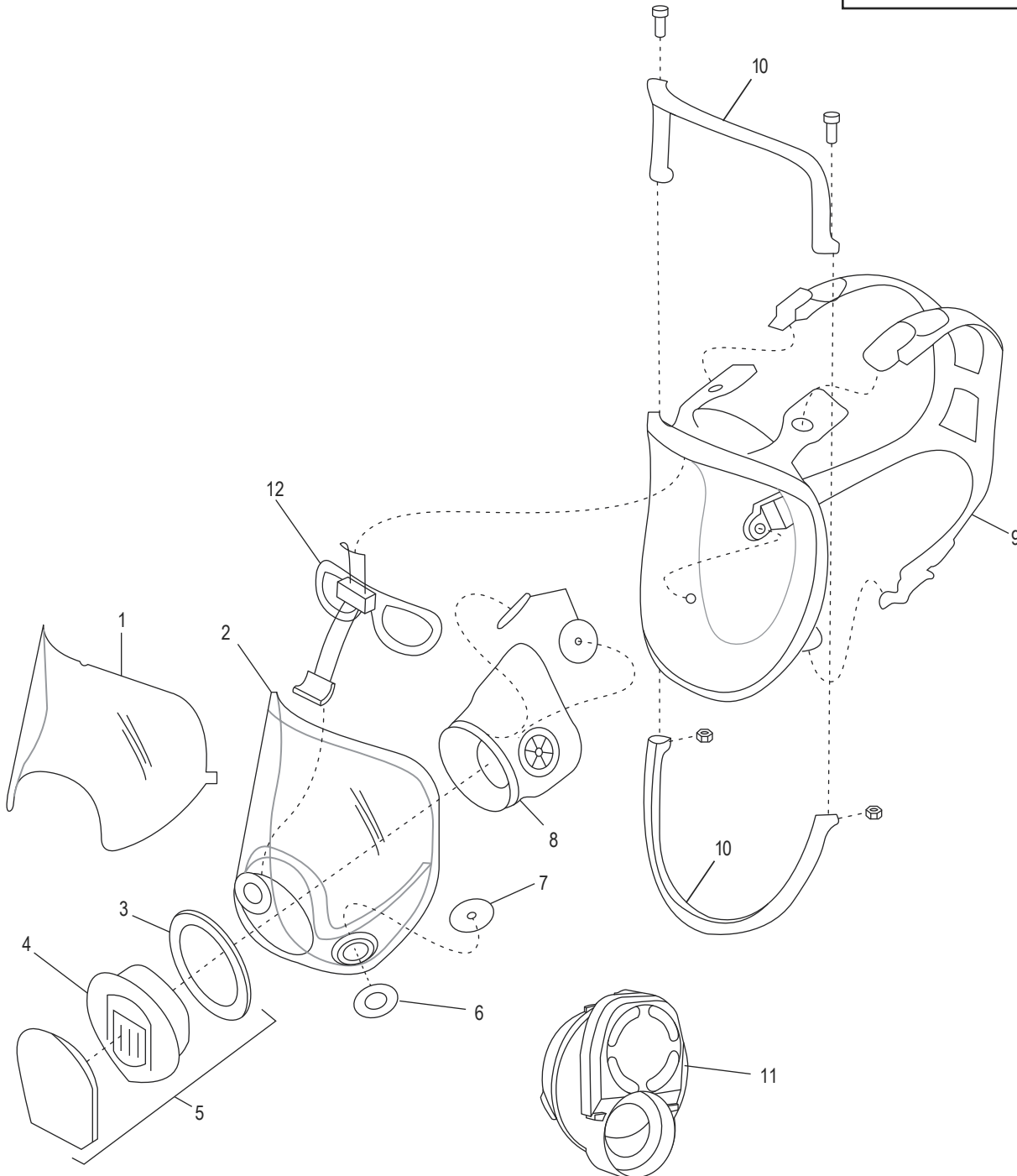
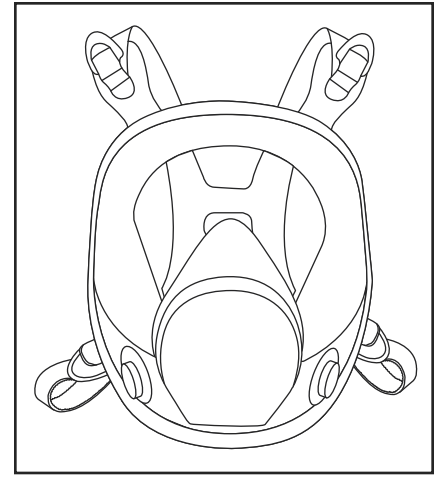

**3M™ 6000 –
RESPIRATEUR À MASQUE
COMPLET RÉUTILISABLE****DIAGRAMME DE PIÈCES**

#	DESCRIPTION	QTÉ.	RÉF. ULINE	RÉF. DU FABRICANT	RÉF. 3M
1	Écran facial (transparent)	1	S-16201	7100138628	6885
2	Ensemble de la lentille	1	H-1472-6898	7000002036	6898
3	Joint d'étanchéité	1	H-1472-6896	7000052122	6896
4	Soupape d'expiration	1	H-1472-7583	7000002159	7583
5	Ensemble de l'adaptateur central	1	-----	7000002178	6864
6	Joint d'inspiration	2	H-1472-GASKT	7000002050	6895
7	Soupape d'inspiration	2	H-1472-6893	7000002049	6893
8	Demi-masque intérieur	1	H-1472-6894	7000002034	6894
9	Serre-tête	1	H-1471-STRAP	7000002035	6897
10	Armature	1	-----	7100001832	6899
11	DIN	1	-----	7000002032	6884

ACCESSOIRES (NON INCLUS)

#	DESCRIPTION	QTÉ.	RÉF. ULINE	RÉF. DU FABRICANT	RÉF. 3M
12	Dispositif de lunettes	1	S-20874	7000002031	6878
	Capuchon à baïonnette (10/paquet)	1	-----	7100006233	6880
	Protège-lentille teinté (25/paquet)	1	S-22979	7000052088	6886
	Lanière de cou	1	-----	7000125977	7883