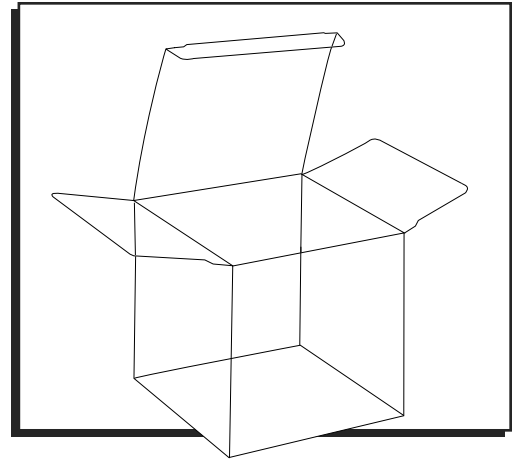


# ULINE S-9730, S-12545 CLEAR VINYL BOXES

1-800-295-5510  
uline.com



## ASSEMBLY

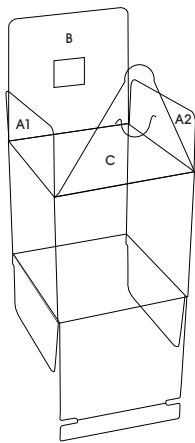


Figure 1

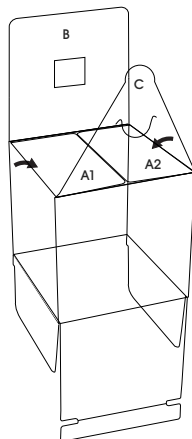


Figure 2

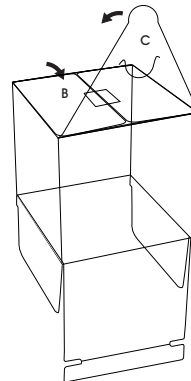


Figure 3

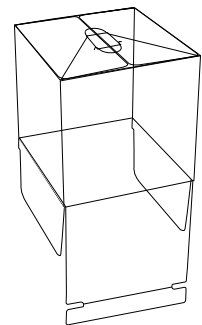


Figure 4

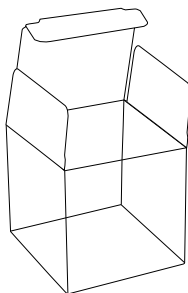


Figure 5

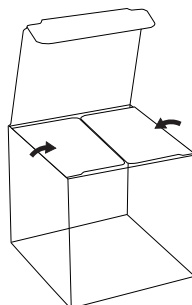


Figure 6

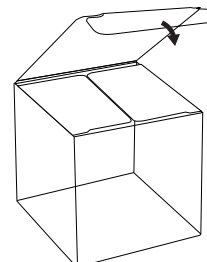


Figure 7

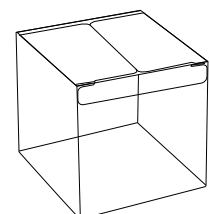


Figure 8

1. Open and crease edges to create box.

### TO CLOSE BOTTOM

1. Crease edges. (See Figure 1)
2. Fold down flaps A1 and A2. (See Figure 2)
3. Fold down flap B. (See Figure 3)
4. Fold down flap C over all other flaps and insert half circles into slot of flap B to close. (See Figures 3-4)

### TO CLOSE TOP

1. Flip box over and crease edges. (See Figure 5)
2. Fold down side flaps. (See Figure 6)
3. Tuck top closed. (See Figure 7-8)

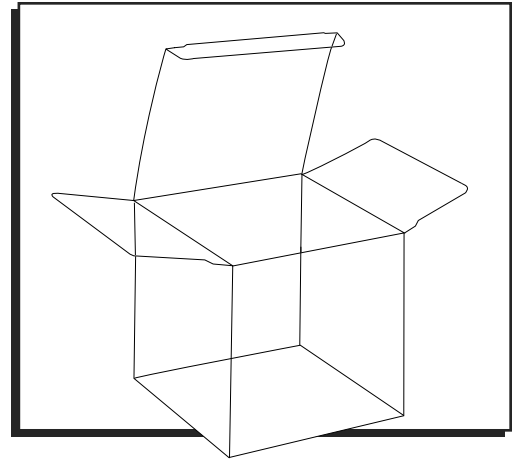
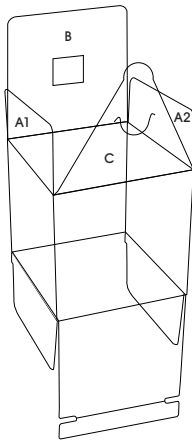
**ENSAMBLE**

Diagrama 1

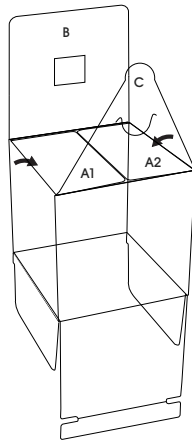


Diagrama 2

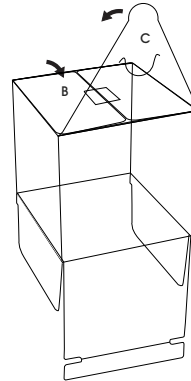


Diagrama 3

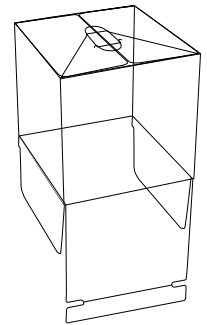


Diagrama 4

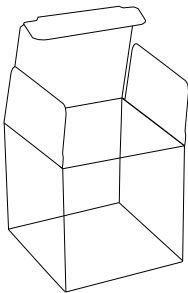


Diagrama 5

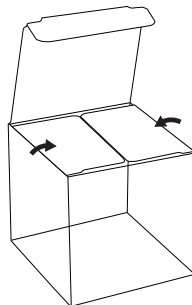


Diagrama 6

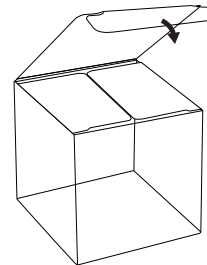


Diagrama 7

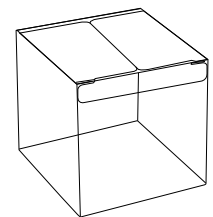


Diagrama 8

1. Abra y pliegue los bordes para crear la caja.

**PARA CERRAR LA BASE**

1. Pliegue los bordes. (Vea Diagrama 1)
2. Doble las solapas a A1 y A2. (Vea Diagrama 2)
3. Doble la solapa B. (Vea Diagrama 3)
4. Doble la solapa C por encima de las otras solapas e inserte los semicírculos en las ranuras de la solapa B para cerrar. (Vea Diagramas 3-4)

**PARA CERRAR LA TAPA**

1. Voltee la caja y pliegue los bordes. (Vea Diagrama 5)
2. Doble las solapas laterales. (Vea Diagrama 6)
3. Inserte la tapa hasta cerrar. (Vea Diagramas 7-8)

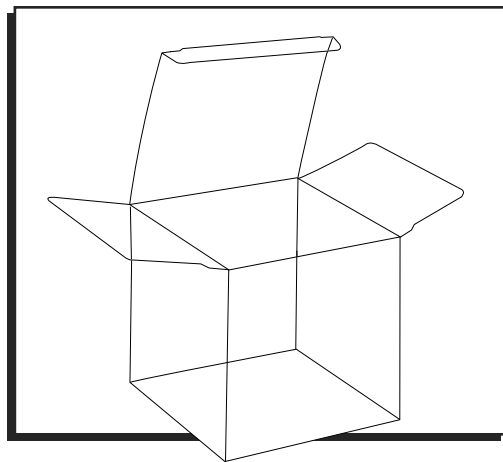
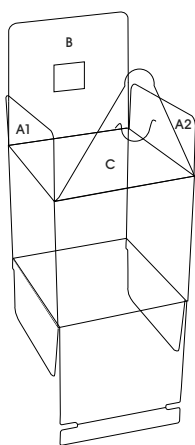
**ASSEMBLAGE**

Figure 1

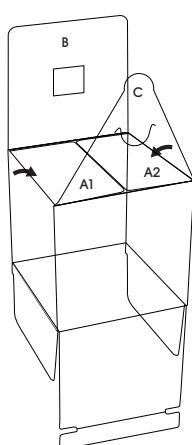


Figure 2

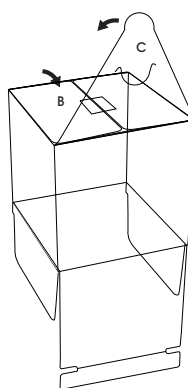


Figure 3

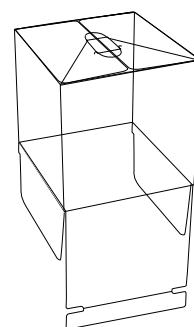


Figure 4

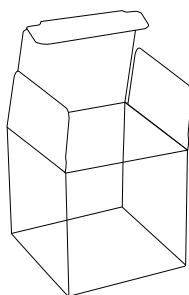


Figure 5

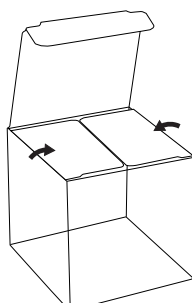


Figure 6

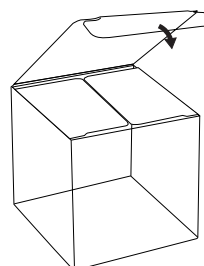


Figure 7

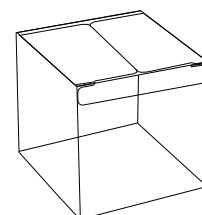


Figure 8

1. Ouvrez et pliez les rebords pour donner la forme de la boîte.

**POUR FERMER LE FOND**

1. Pliez les rebords. (Voir Figure 1)
2. Pliez les rabats A1 et A2 vers le bas. (Voir Figure 2)
3. Pliez le rabat B vers le bas. (Voir Figure 3)
4. Pliez le rabat C par-dessus tous les autres rabats et insérez les demi-cercles dans la fente du rabat B pour fermer. (Voir Figures 3 et 4)

**POUR FERMER LE COUVERCLE**

1. Retournez la boîte et pliez les rebords. (Voir Figure 5)
2. Pliez les rabats latéraux vers le bas. (Voir Figure 6)
3. Fermez le couvercle en faisant rentrer le rabat. (Voir Figures 7 et 8)