

ASSEMBLY

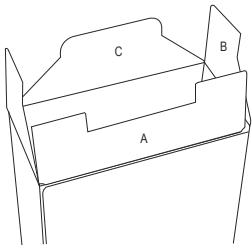


Figure 1

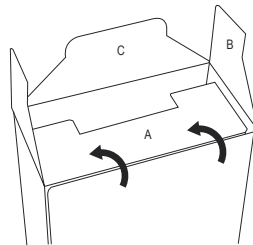


Figure 2

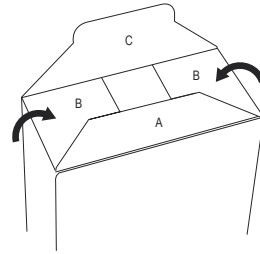


Figure 3

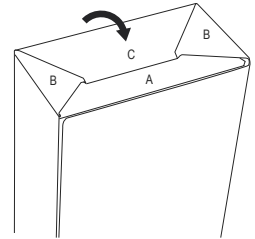


Figure 4

1. Open and crease flattened edges to create box. (See Figure 1)

TO CLOSE BOTTOM

1. Fold down flap (A). (See Figure 2)
2. Fold down flaps (B), tucking centers under opening on flap (A). (See Figures 2 and 3)
3. Fold down flap (C) over flaps (B) tucking in center under opening on flap (A). (See Figure 4)

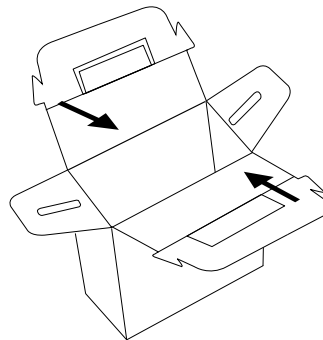


Figure 5

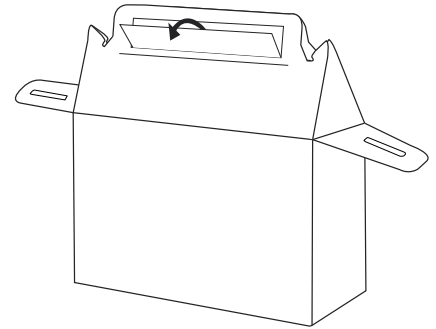


Figure 6

TO CLOSE TOP

1. Bring together sides with handles. (See Figure 5)
2. Fold over piece between handles. (See Figure 6)
3. Tuck edges into openings on side flaps. (See Figure 7)

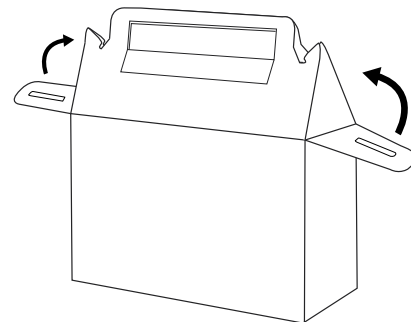


Figure 7

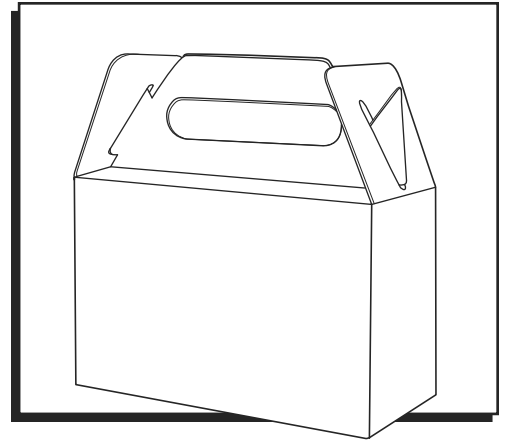
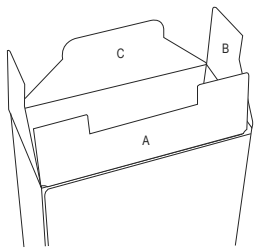
**ENSAMBLE**

Diagrama 1

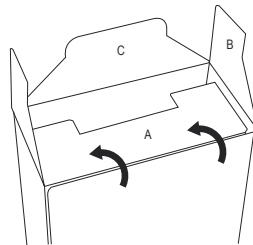


Diagrama 2

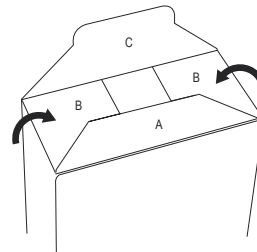


Diagrama 3

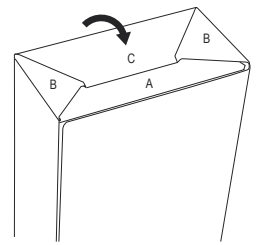


Diagrama 4

1. Abra y pliegue los bordes aplanados para crear la caja. (Vea Diagrama 1)

PARA CERRAR LA BASE

1. Doble hacia abajo la solapa (A). (Vea Diagrama 2)
2. Doble hacia abajo las solapas (B), metiendo los centros debajo de la abertura en la solapa (A). (Vea Diagramas 2 y 3)
3. Doble hacia abajo la solapa (C) sobre las solapas (B) metiendo el centro debajo de la abertura en la solapa (A). (Vea Diagrama 4)

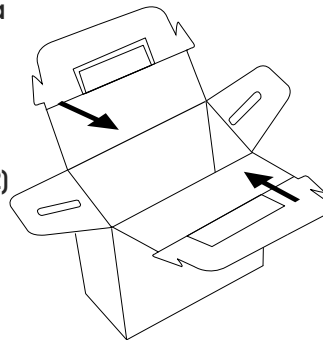


Diagrama 5

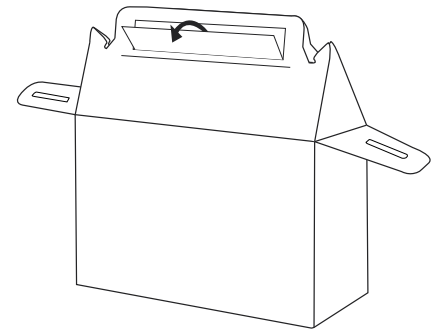


Diagrama 6

PARA CERRAR LA PARTE SUPERIOR

1. Junte todos los lados con asas. (Vea Diagrama 5)
2. Doble la pieza que está entre las asas. (Vea Diagrama 6)
3. Meta los bordes dentro de las aberturas en las solapas laterales. (Vea Diagrama 7)

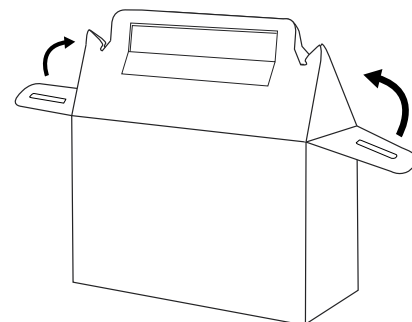


Diagrama 7

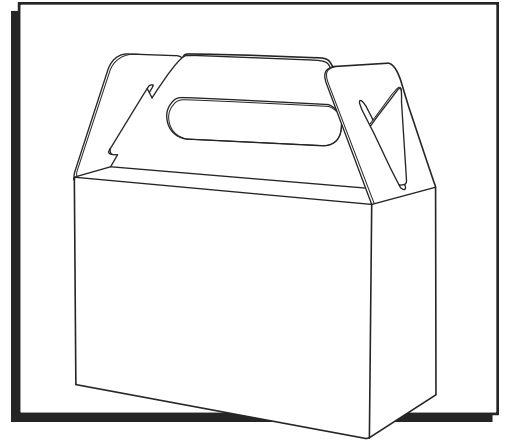
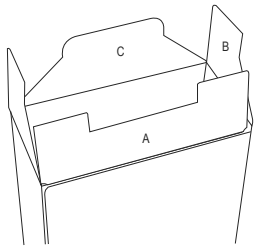
**ASSEMBLAGE**

Figure 1

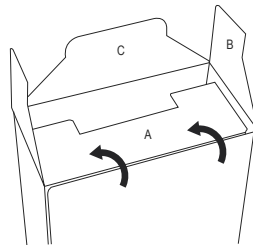


Figure 2

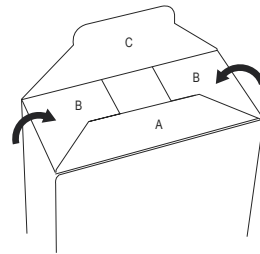


Figure 3

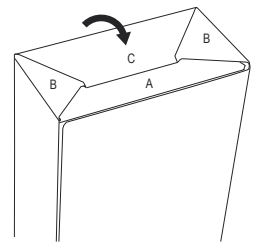


Figure 4

1. Ouvrez et pliez les bords aplatis pour créer la boîte. (Voir Figure 1)

POUR FERMER LE BAS

1. Pliez le rabat (A) vers le bas. (Voir Figure 2)
2. Pliez les rabats (B) et insérez-les dans l'ouverture sur le rabat (A). (Voir Figures 2 et 3)
3. Pliez le rabat (C) vers le bas, en dessus du rabat (B) et insérez-les dans l'ouverture sur le rabat (A). (Voir Figure 4)

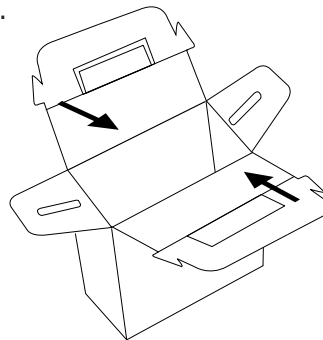


Figure 5

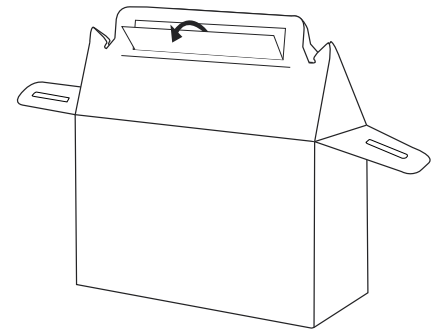


Figure 6

POUR FERMER LE DESSUS

1. Rassemblez les côtés avec poignées. (Voir Figure 5)
2. Pliez le morceau entre les poignées. (Voir Figure 6)
3. Insérez les bouts dans les ouvertures sur les rabats latéraux. (Voir Figure 7)

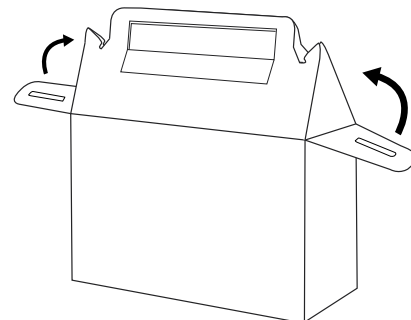


Figure 7