

**ULINE** S-18441

**CORSTAT™**  
**IN-PLANT HANDLER –**  
**23 x 12 x 13"**

1-800-295-5510  
uline.com

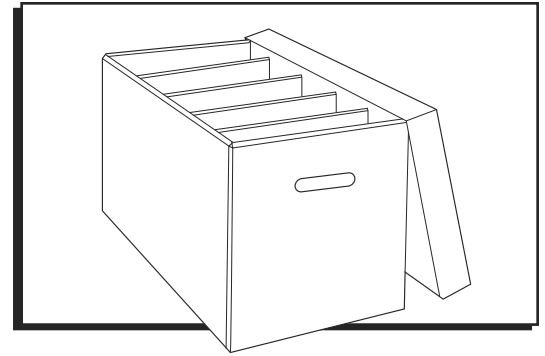

## BOX ASSEMBLY

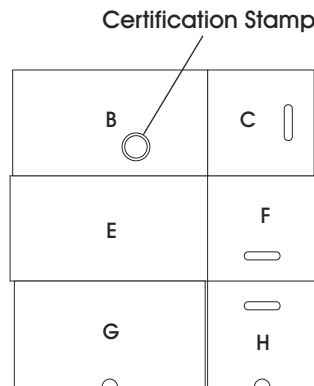
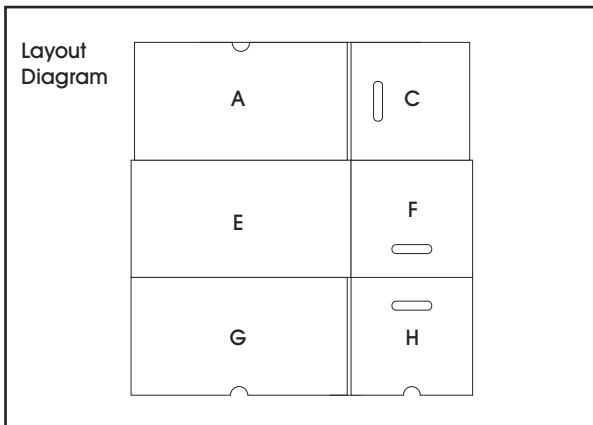

Figure 1

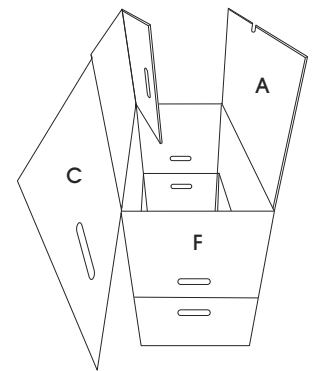

Figure 2

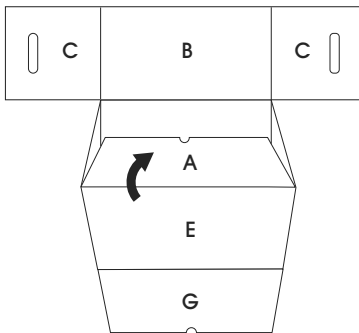

Figure 3

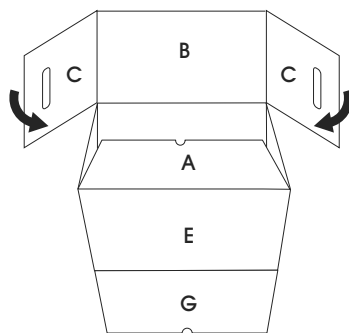

Figure 4

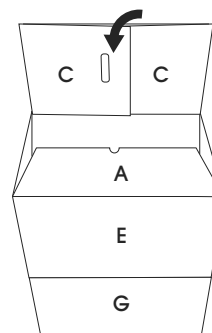

Figure 5

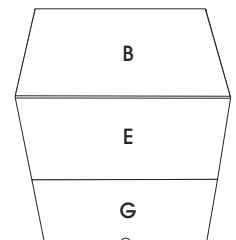

Figure 6

1. Hold box with certification stamp facing away and upside down. (See Figure 1)
2. Fold box to create a rectangle shape with the certification stamp on the top. (See Figure 2)
3. Fold interior bottom flap (A) inward. (See Figure 3)
4. Fold left and right side flaps (C) toward the exterior bottom panel (B). (See Figure 4)
5. Fold the exterior bottom panel along with the folded side flaps inward. (See Figures 5-6)
6. Turn the box over so that the certification stamp is side down and the box opening is on top. (See Figure 7)

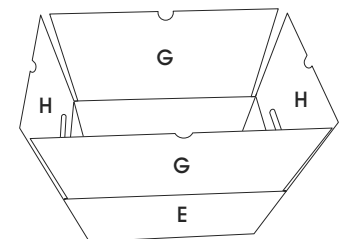

Figure 7

## BOX ASSEMBLY CONTINUED

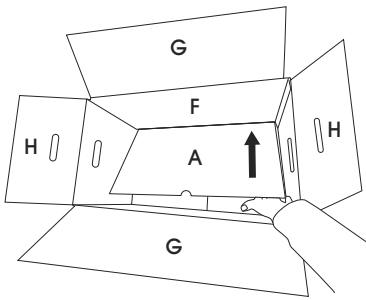

Figure 8

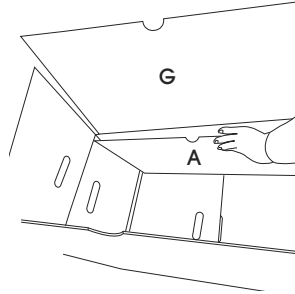

Figure 9

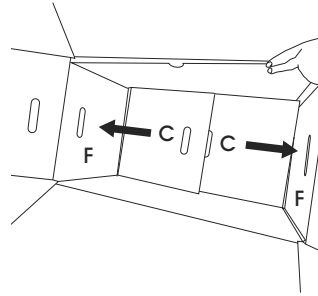

Figure 10

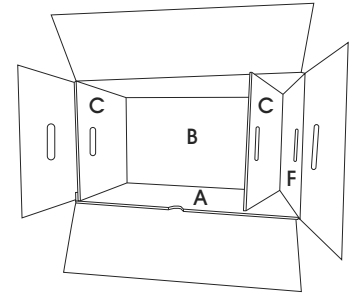

Figure 11

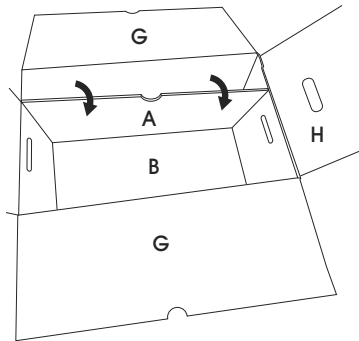

Figure 12

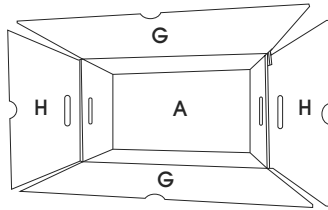

Figure 13

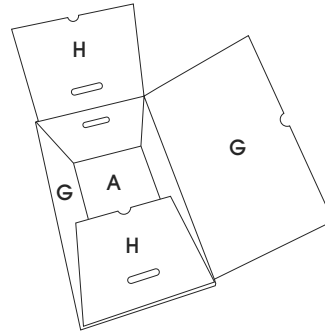

Figure 14

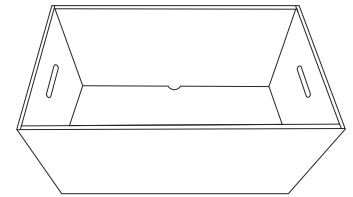

Figure 15

7. Lift interior bottom flap (A) flush against the front panel (E). (See Figures 8-9)
8. Lift the two side flaps (C) flush against the respective side panels (F). (See Figures 10-11)
9. Push down the interior bottom flap (A) so that it is flat against the exterior bottom panel (B). (See Figures 12-13)
10. Fold down all four flaps (H, G) one by one to finish the box. (See Figure 14)
11. Box is assembled. (See Figure 15)

## BOX LID ASSEMBLY

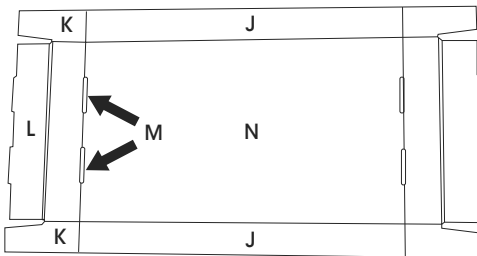

Figure 16

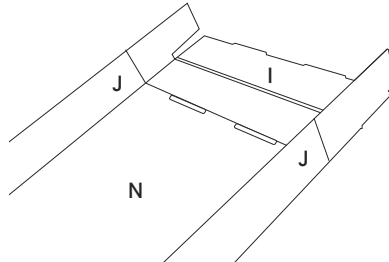

Figure 17

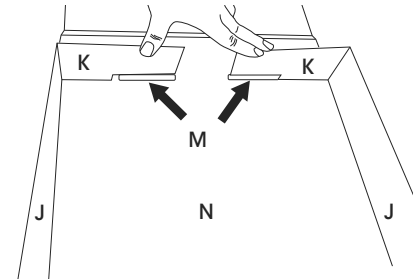

Figure 18

1. Fold in lid sides (J) along the crease. (See Figures 16-17)
2. On one side of the box lid, fold in lid sides (K) over slots (M). (See Figure 18)

## BOX LID ASSEMBLY CONTINUED

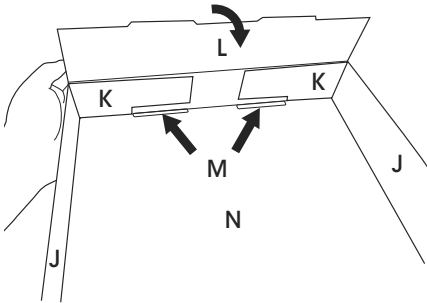

Figure 19

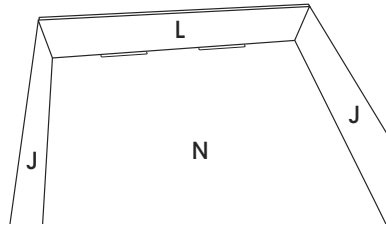

Figure 20

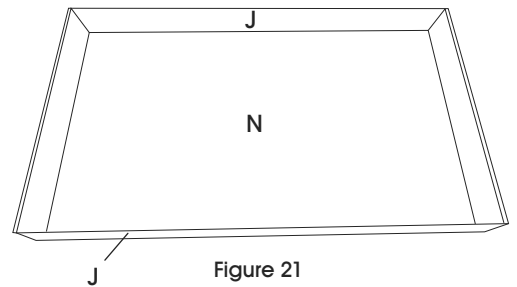

Figure 21

3. On the same side, fold box top lid (L) over tabs (K), locking the top lids tabs into slots (M) on the top panel. (See Figures 19-20)
4. Repeat steps 1-3 for the other side.
5. Lid is assembled. (See Figure 21)

## BOX DIVIDER ASSEMBLY

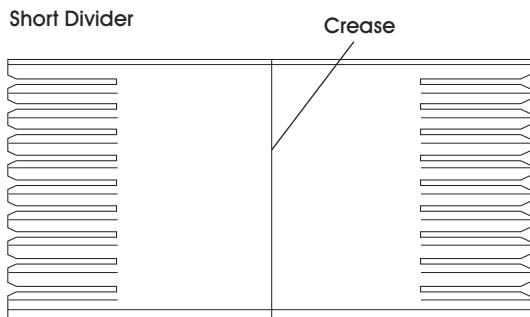

Figure 22

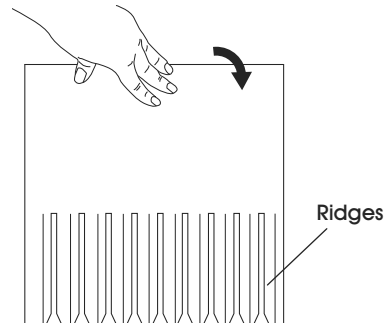

Figure 23

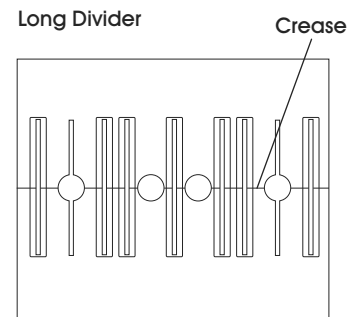

Figure 24

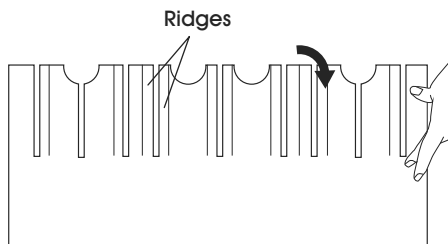

Figure 25

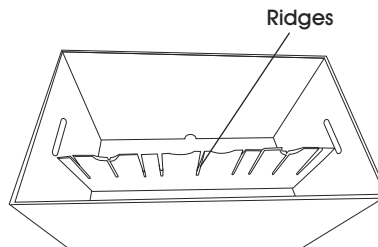

Figure 26

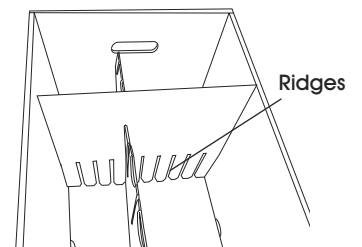

Figure 27

1. Fold short divider along the crease line. (See Figures 22-23)
2. Fold long divider along the crease line. (See Figures 24-25)
3. Insert long divider into the box as needed, ridges facing upward. (See Figure 26)
4. Insert short divider into the box as needed, ridges facing downward and align with the ridge from the long divider. (See Figure 27)

**ULINE**

1-800-295-5510  
uline.com

**ULINE S-18441**  
**CORSTAT™ CAJA**  
**CON DIVISORES –**  
**23 x 12 x 13"**

800-295-5510  
 uline.mx

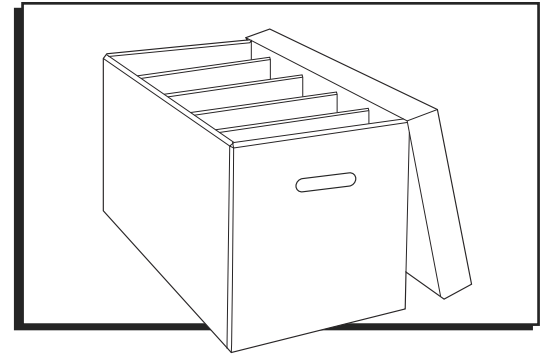

**ENSAMBLE DE LA CAJA**

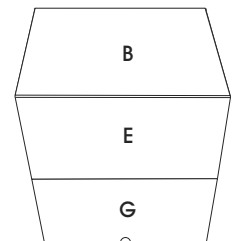
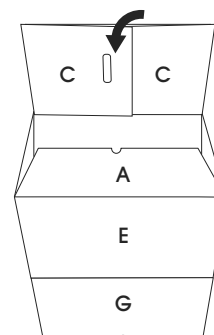
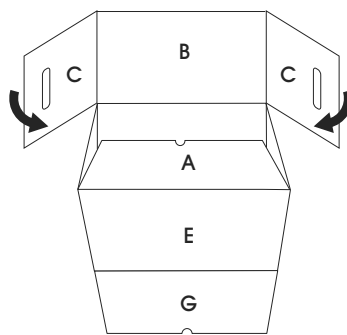
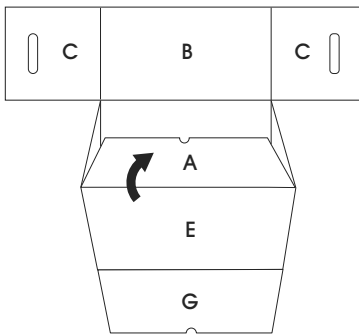
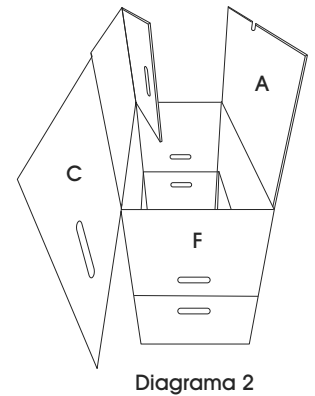
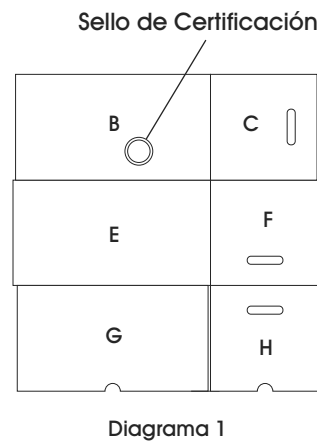
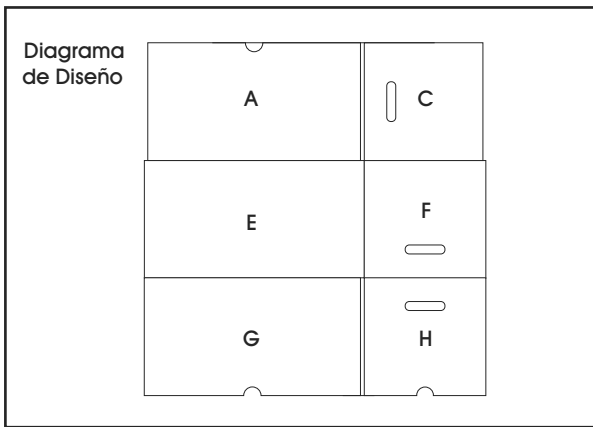

1. Sostenga la caja con el sello de certificación mirando del lado opuesto y boca abajo. (Vea Diagrama 1)
2. Doble la caja para crear una forma rectangular con el sello de certificación en la parte superior. (Vea Diagrama 2)
3. Doble la solapa interior inferior (A) hacia adentro. (Vea Diagrama 3)
4. Doble las solapas laterales izquierda y derecha (C) hacia el panel inferior exterior (B). (Vea Diagrama 4)
5. Doble el panel inferior exterior junto con las solapas laterales dobladas hacia adentro. (Vea Diagramas 5-6)
6. Voltee la caja de forma que el sello de certificación quede hacia abajo y la abertura esté en la parte superior. (Vea Diagrama 7)

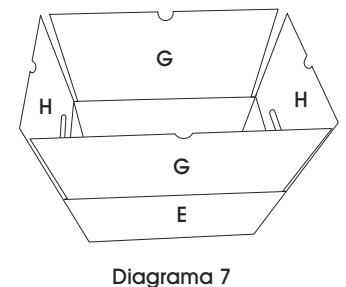

## CONTINUACIÓN DEL ENSAMBLE DE LA CAJA



Diagrama 8



Diagrama 9

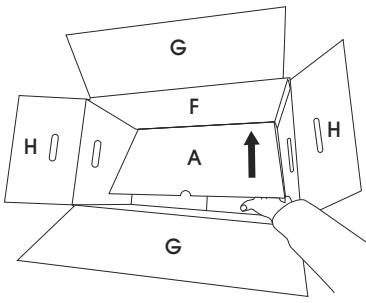

Diagrama 10

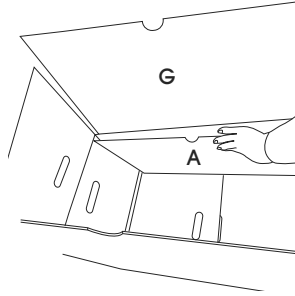

Diagrama 11

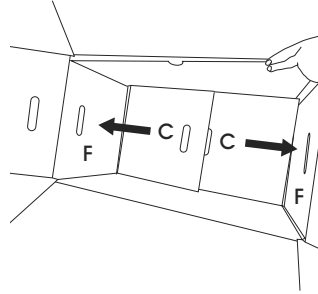

Diagrama 12

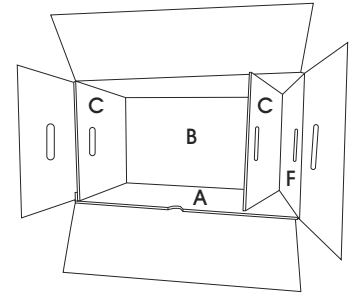

Diagrama 13

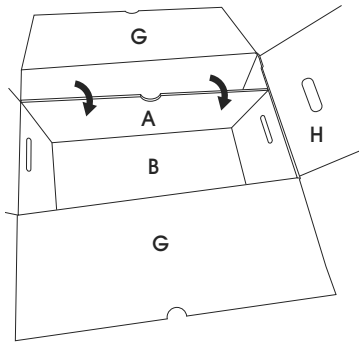

Diagrama 14

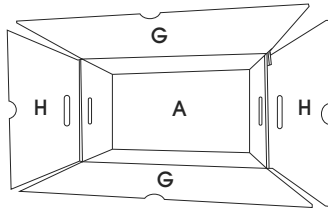

Diagrama 15

7. Levante la solapa inferior interior (A) nivelada contra el panel frontal (E). (Vea Diagramas 8-9)
8. Levante las solapas laterales (C) niveladas contra sus respectivos paneles laterales (F). (Vea Diagramas 10-11)
9. Empuje la solapa inferior (A) al interior para que quede al ras del panel interior interior (B). (Vea Diagramas 12-13)
10. Doble las cuatro solapas (H, G) una por una para terminar la caja. (Vea Diagrama 14)
11. La caja ya está ensamblada. (Vea Diagrama 15)

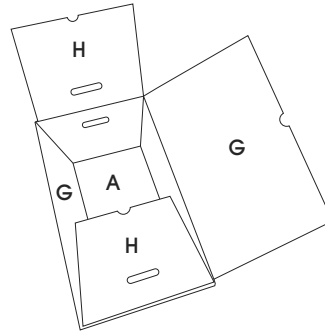
## ENSAMBLE DE LA TAPA DE LA CAJA

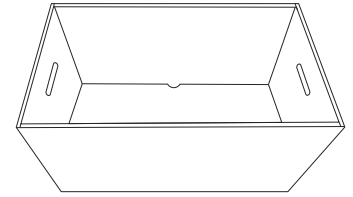

Diagrama 16



Diagrama 17

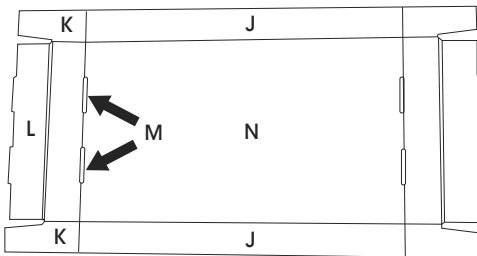

Diagrama 18

1. Doble los laterales de la tapa (J) a lo largo del pliegue. (Vea Diagramas 16-17)
2. En un lado de la tapa de la caja, doble los laterales de la tapa (K) sobre las ranuras (M). (Vea Diagrama 18)

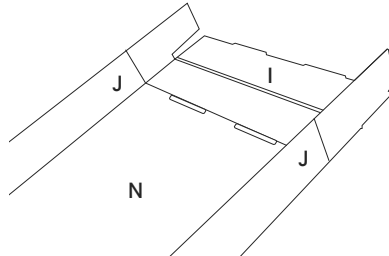
## CONTINUACIÓN DEL ENSAMBLE DE LA TAPA DE LA CAJA

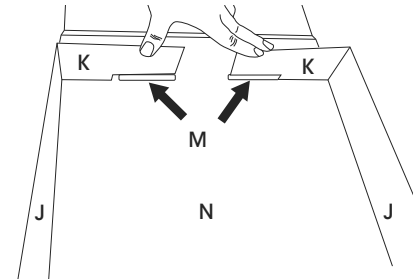

Diagrama 19



Diagrama 20

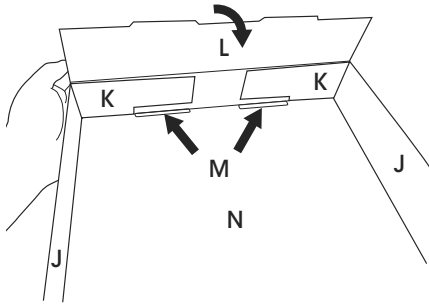

Diagrama 21

3. En el mismo lado, doble la tapa superior de la caja (L) sobre las pestañas (K), fijando las pestañas de las tapas superiores en las ranuras (M) en el panel superior. (Vea Diagramas 19-20)
4. Repita los pasos 1-3 en el otro lado.
5. La tapa ya está ensamblada. (Vea Diagrama 21)

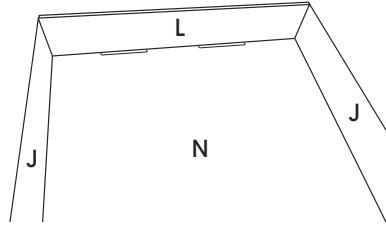
## ENSAMBLE DE LOS DIVISORES DE LA CAJA

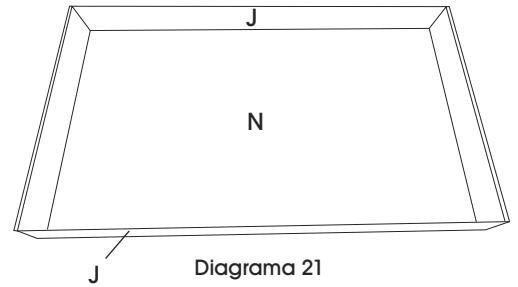

Diagrama 22



Diagrama 23

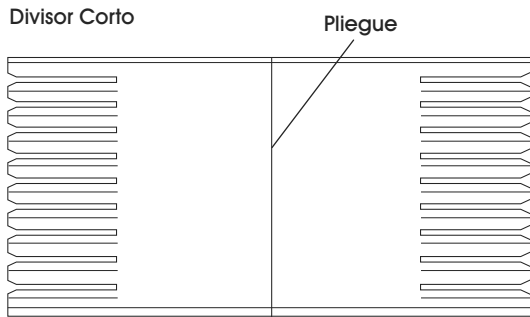

Diagrama 24

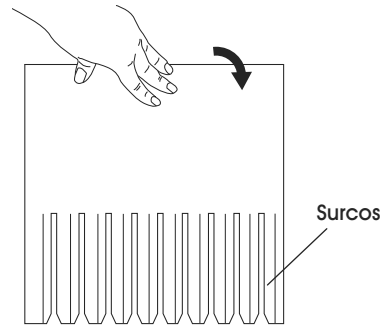

Diagrama 25

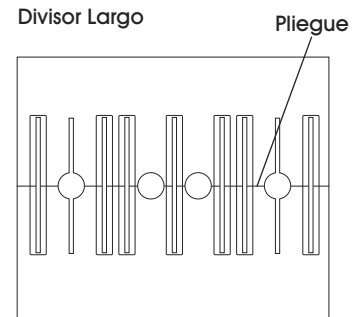

Diagrama 26

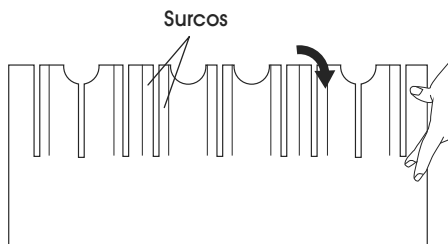

Diagrama 27

1. Doble el divisor corto a la par de la línea de pliegue. (Vea Diagramas 22-23)
2. Doble el divisor largo a la par de la línea de pliegue. (Vea Diagramas 24-25)
3. Inserte el divisor largo dentro de la caja como se necesite, los surcos viendo hacia arriba. (Vea Diagrama 26)
4. Inserte el divisor corto dentro de la caja como se necesite, los surcos mirando hacia abajo y alinearse con el surco del divisor largo. (Vea Diagrama 27)

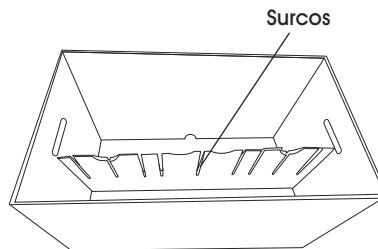
**ULINE**

800-295-5510

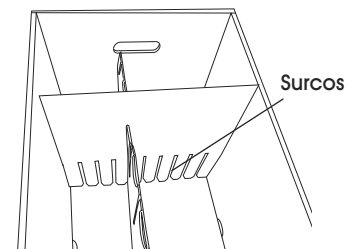
uline.mx

**ULINE** S-18441

**CORSTAT<sup>MC</sup> – DISPOSITIF  
DE MANUTENTION EN  
USINE – 23 x 12 x 13 PO**

1-800-295-5510  
uline.ca

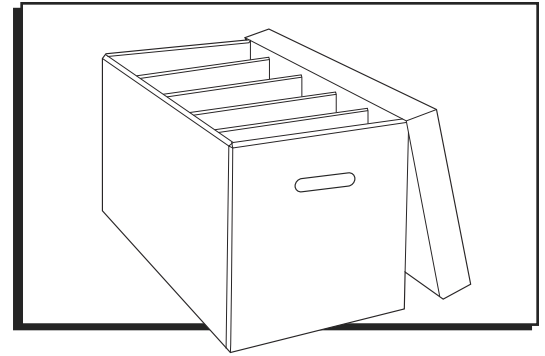

## MONTAGE DE LA BOÎTE

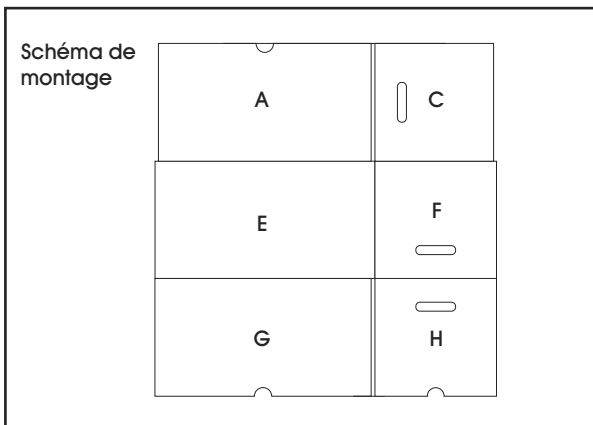

Cachet d'authentification

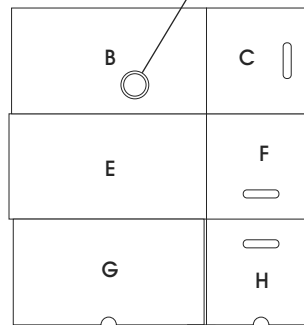

Figure 1

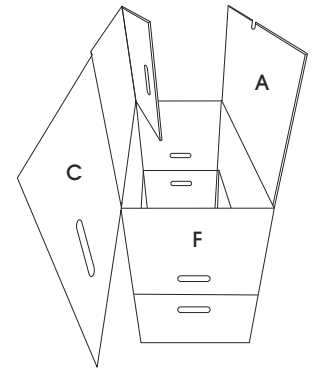

Figure 2

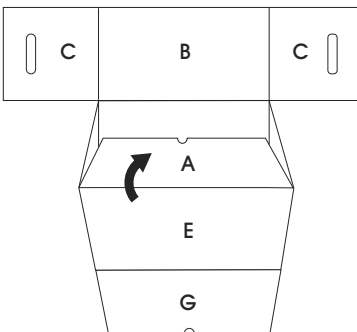

Figure 3

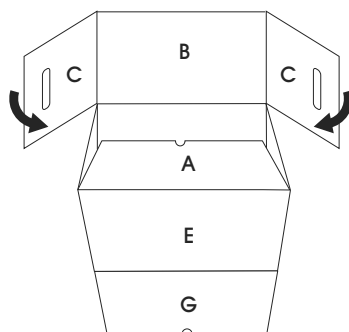

Figure 4

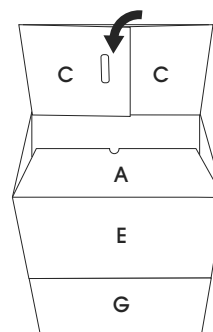

Figure 5

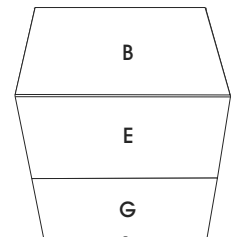

Figure 6

1. Placez la boîte de manière à ce que le cachet d'authentification soit à l'envers et orienté vers l'extérieur. (Voir Figure 1)
2. Pliez la boîte pour créer une forme rectangulaire, le cachet d'authentification orienté vers le haut. (Voir Figure 2)
3. Pliez vers l'intérieur le rabat inférieur qui se trouve le plus près de vous (A). (Voir Figure 3)
4. Pliez les rabats latéraux gauche et droite (C) vers le panneau extérieur du bas (B). (Voir Figure 4)
5. Pliez vers l'intérieur le panneau extérieur du bas ainsi que les panneaux latéraux pliés. (Voir Figure 5 et 6)
6. Tournez la boîte de manière à ce que le cachet d'authentification se trouve vers le bas et l'ouverture de la boîte vers le haut. (Voir Figure 7)

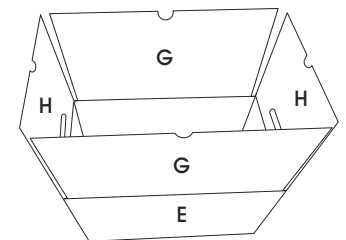

Figure 7

## MONTAGE SUITE

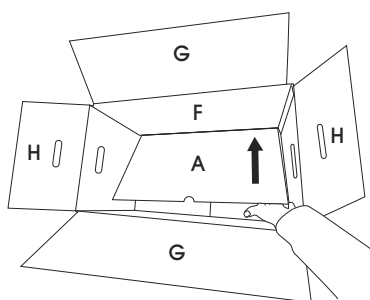

Figure 8

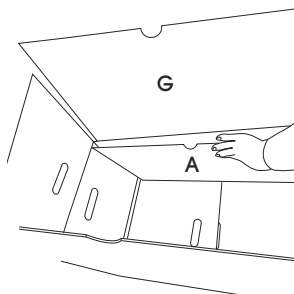

Figure 9

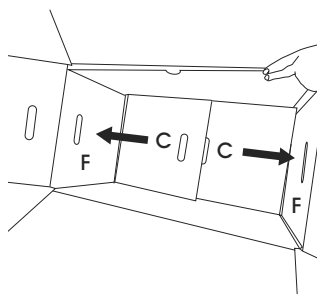

Figure 10

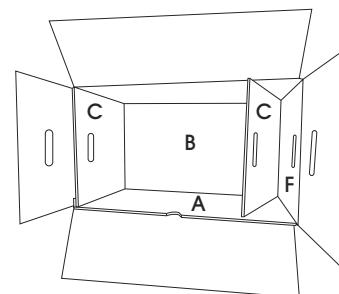

Figure 11

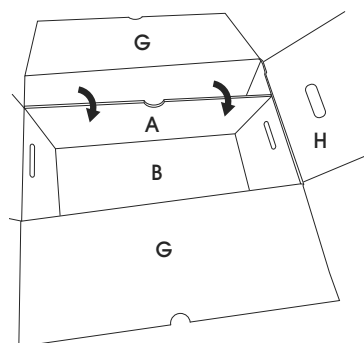

Figure 12

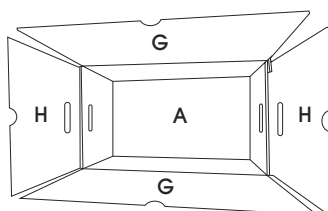

Figure 13

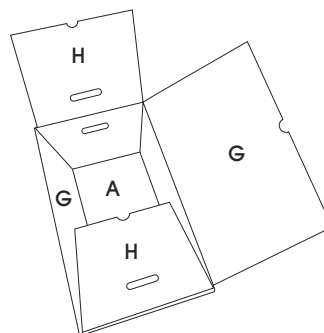

Figure 14

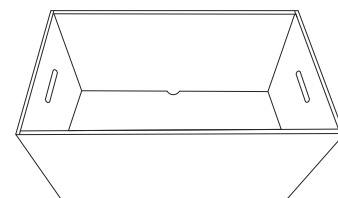

Figure 15

7. Soulevez le rabat inférieur à l'intérieur (A) contre le panneau avant (E). (Voir Figure 8 et 9)
8. Soulevez les deux rabats latéraux (C) contre leurs panneaux latéraux respectifs (F). (Voir Figure 10 et 11)
9. Poussez le rabat du bas intérieur (A) de manière à ce qu'il soit à plat contre le panneau du bas extérieur. (Voir Figure 12 et 13)
10. Pliez un par un vers le bas les quatre rabats (H, G) pour terminer la boîte. (Voir Figure 14)
11. La boîte est assemblée. (Voir Figure 15)

## MONTAGE DU COUVERCLE DE BOÎTE

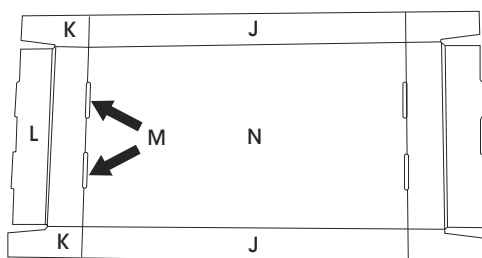

Figure 16

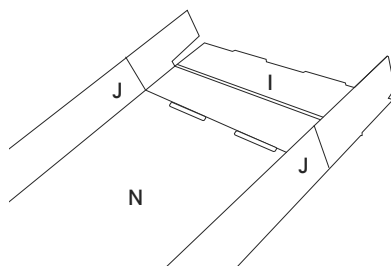

Figure 17

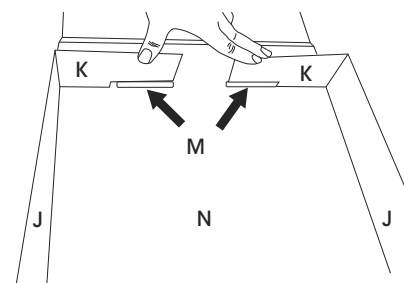

Figure 18

1. Pliez les côtés du couvercle (J) le long de la rainure. (Voir Figure 16 et 17)
2. Sur un des côtés du couvercle, pliez les côtés (K) au-dessus des fentes (M). (Voir Figure 18)



## MONTAGE DU COUVERCLE DE BOÎTE SUITE

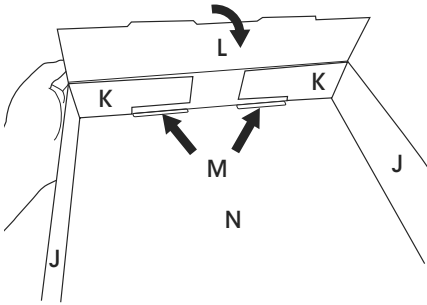

Figure 19

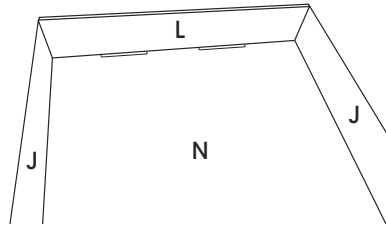

Figure 20

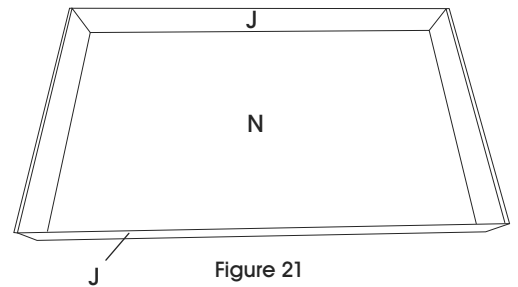

Figure 21

3. Sur le même côté, pliez le couvercle supérieur de la boîte (L) au-dessus des languettes (K) et insérez les languettes dans les fentes (M) du panneau supérieur. (Voir Figure 19 et 20)
4. Répétez les étapes 1 à 3 de l'autre côté.
5. Le couvercle est assemblé. (Voir Figure 21)

## MONTAGE DES SÉPARATEURS DE BOÎTE

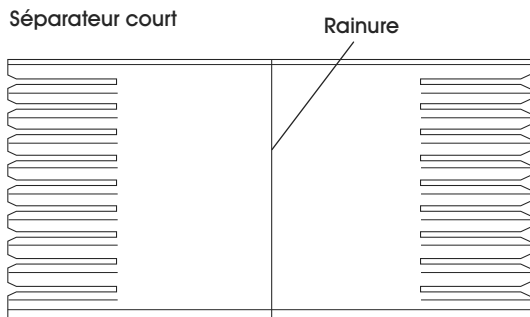

Figure 22

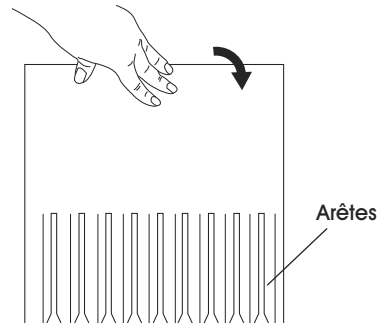

Figure 23

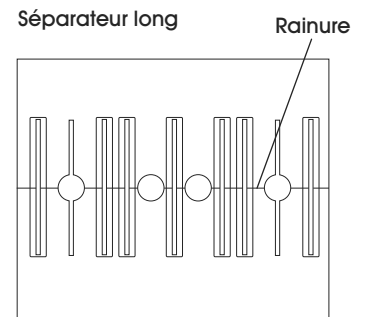

Figure 24

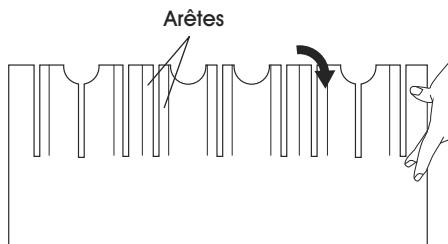

Figure 25

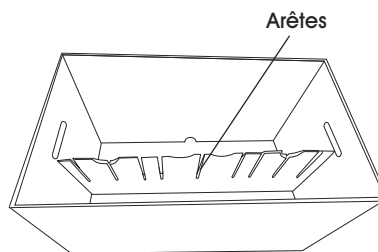

Figure 26

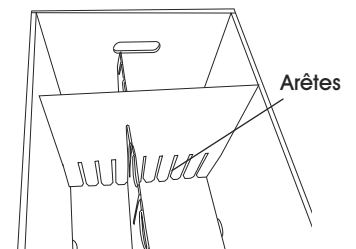

Figure 27

1. Pliez le séparateur court le long de la rainure. (Voir Figure 22 et 23)
2. Pliez le séparateur long le long de la rainure. (Voir Figure 24 et 25)
3. Insérez dans la boîte et à la position désirée le séparateur long, arêtes orientées vers le haut. (Voir Figure 26)
4. Insérez dans la boîte et à la position désirée le séparateur court, arêtes orientées vers le bas et alignées sur les arêtes du séparateur long. (Voir Figure 27)

**ULINE**

1-800-295-5510  
uline.ca