

ULINE S-12330

3 TIER CD DISPLAY

1-800-295-5510
uline.com

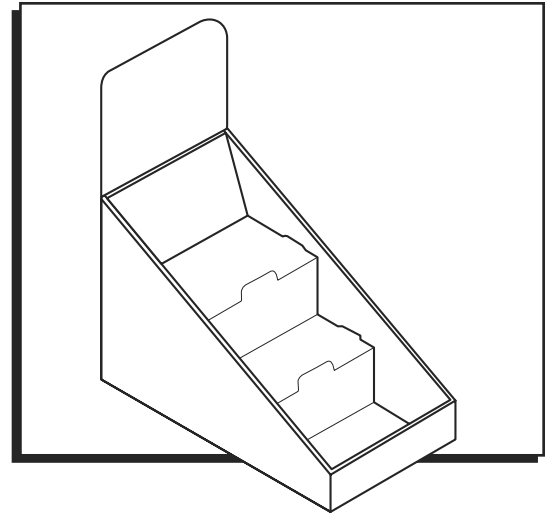

ASSEMBLY

1. Pre-break scores on display and square up the side panels. (See Figure 1)

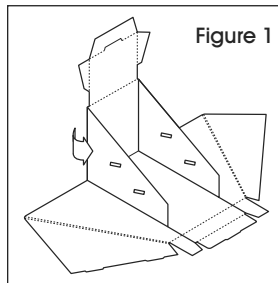

2. Fold over side flaps and front lip. Lock them into the slots at the display bottom. (See Figure 2)

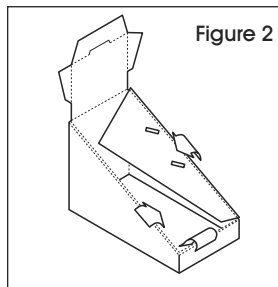

3. Pre-break scores on the insert and fold into step formation as shown. (See Figure 3)

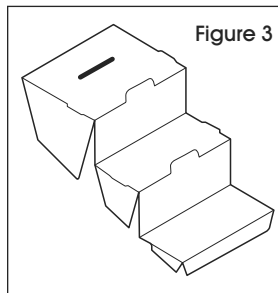

4. Place insert in display. The tabs on the side of the insert should align with and snap into the slots on the side panels of the display. (See Figure 4)

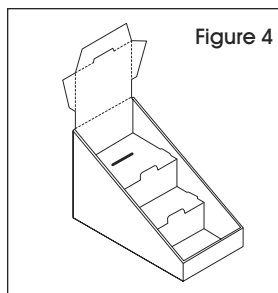

5. Fold in angled side flaps on back panel. (See Figure 5)

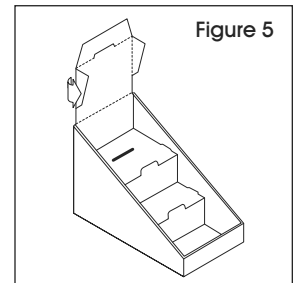

6. Fold over back panel and snap tab into the slot on the top tier of the insert. (See Figure 6)

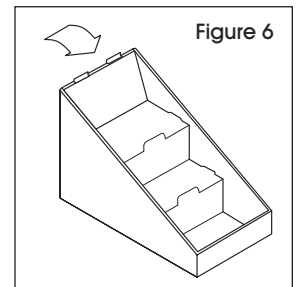

7. Insert header. Header tabs should slide into slots on the back panel scores. (See Figure 7)

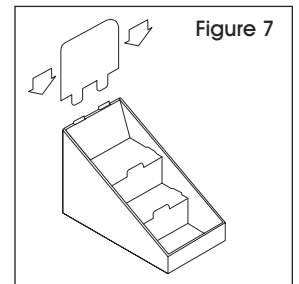

ULINE S-12330
EXHIBIDOR PARA
CDS DE 3 NIVELES

800-295-5510
uline.mx

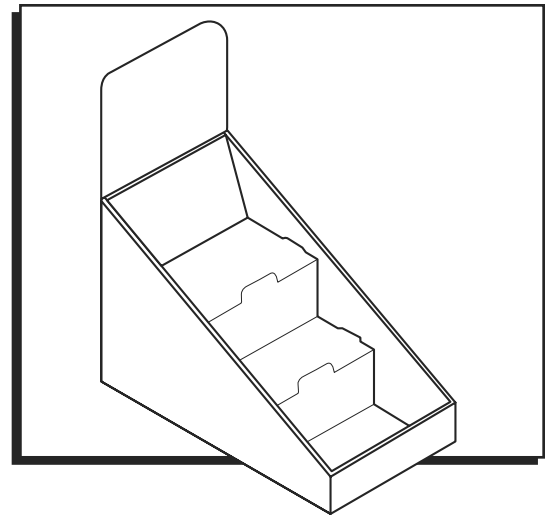

ENSAMBLE

1. Separe los niveles del exhibidor y doble los paneles laterales en ángulo recto. (Vea Diagrama 1)

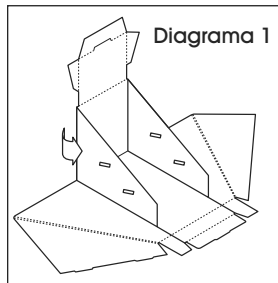

2. Doble las solapas laterales y el reborde frontal. Trábelas en las ranuras de la parte inferior del exhibidor. (Vea Diagrama 2)

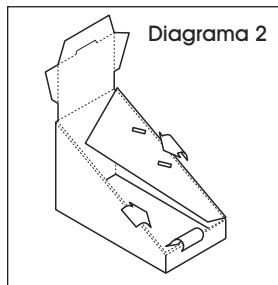

3. Separe los niveles del inserto y dóblelos en formación de escalera, como se muestra. (Vea Diagrama 3)

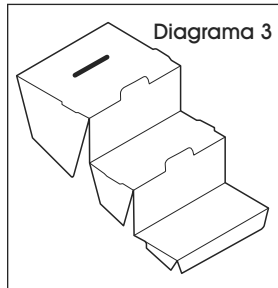

4. Coloque el inserto en el exhibidor. Las lengüetas del lateral del inserto deberán quedar alineadas e insertarse en las ranuras de los paneles laterales del exhibidor. (Vea Diagrama 4)

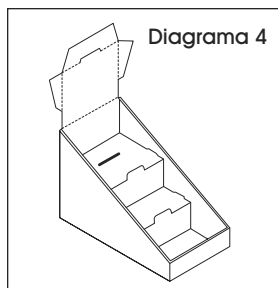

5. Doble hacia adentro las solapas laterales en ángulo del panel posterior. (Vea Diagrama 5)

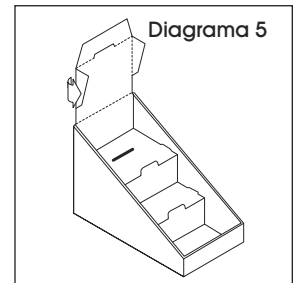

6. Doble el panel posterior hacia atrás e inserte la lengüeta en la ranura de la del nivel superior del inserto. (Vea Diagrama 6)

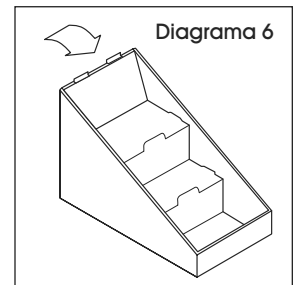

7. Inserte la cabecera. Las lengüetas de la cabecera deben deslizarse en las ranuras de los niveles del panel posterior. (Vea Diagrama 7)

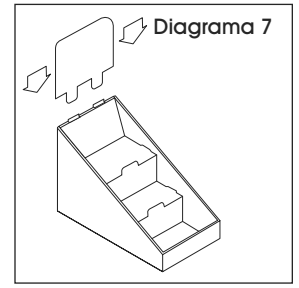

ULINE S-12330
PRÉSENTOIR À CD
À TROIS NIVEAUX

1-800-295-5510
uline.ca

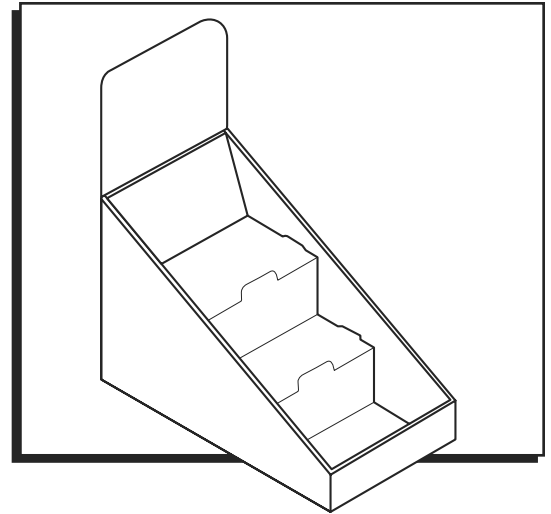

ASSEMBLAGE

1. Commencez par plier le long des différents plis du présentoir, puis formez les panneaux latéraux. (Voir Figure 1)

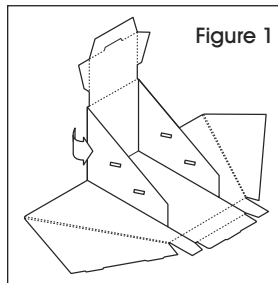

2. Repliez les rabats latéraux et le rebord avant. Insérez-les dans les fentes au bas du présentoir. (Voir Figure 2)

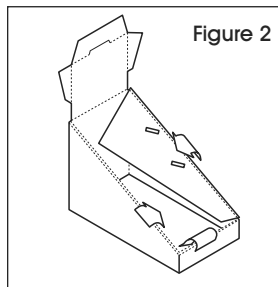

3. Pliez le long des plis de l'encart, puis formez les niveaux comme illustré. (Voir Figure 3)

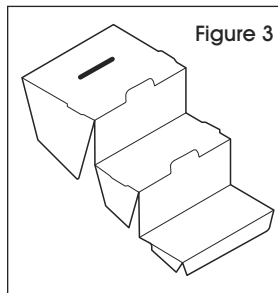

4. Placez l'encart dans le présentoir. Les languettes sur le côté de l'encart doivent s'aligner et s'encliqueter dans les fentes sur les panneaux latéraux du présentoir. (Voir Figure 4)

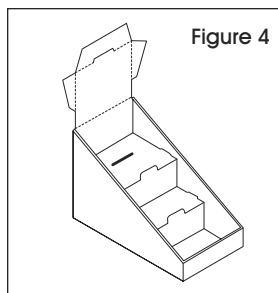

5. Repliez les rabats latéraux angulés du panneau arrière vers l'intérieur. (Voir Figure 5)

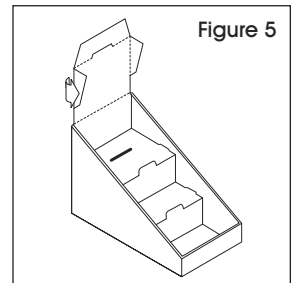

6. Pliez le panneau arrière vers l'avant et encliquez la languette dans la fente du niveau supérieur de l'encart. (Voir Figure 6)

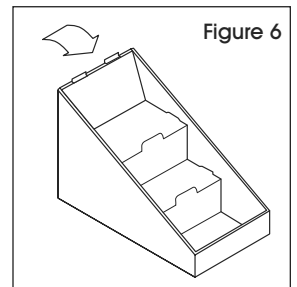

7. Insérez l'en-tête. Les languettes de l'en-tête doivent s'insérer dans les fentes dans les plis du panneau arrière. (Voir Figure 7)

