

ULINE H-8668 DELUXE SHELTER SIDE WALLS

1-800-295-5510
uline.com

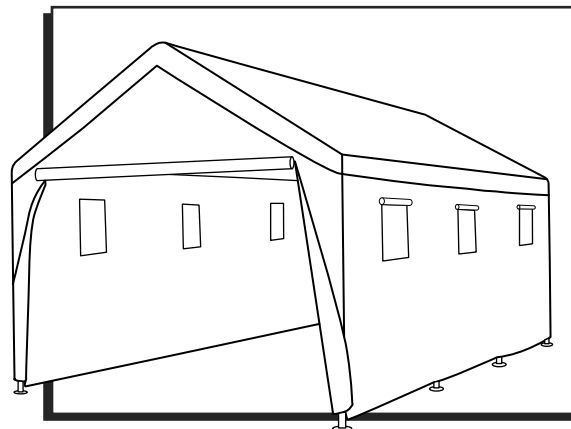

PARTS

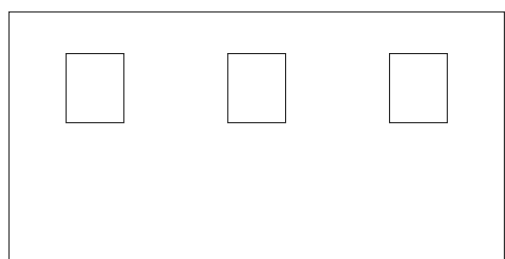

Side Wall x 2

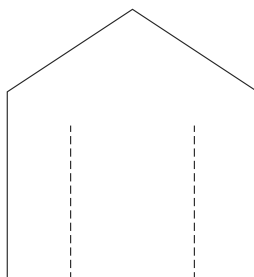

Front Wall x 1

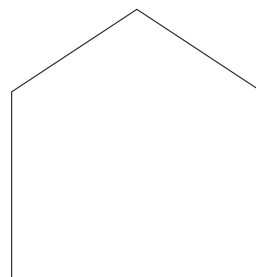

Back Wall x 1



Elastic Ball Strap x 28

ASSEMBLY

1. Unfold the back wall, front wall and each side wall.
2. Find the hook and loop fastening strips on one length of one side wall. Place these strips on the top pipe of the shelter by wrapping the strips over the perimeter poles. (See Figure 1)
3. Repeat with second side wall, rear wall and front wall.
4. After connecting the top of the side walls and installing the leg pipes into the connectors (see H-8667 deluxe shelter instructions) on the perimeter of the shelter, use elastic ball straps to connect the end of each side wall to each corner.

Figure 1

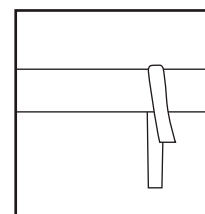
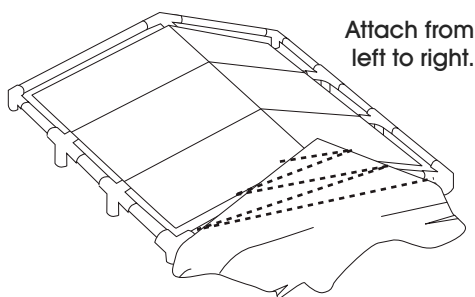
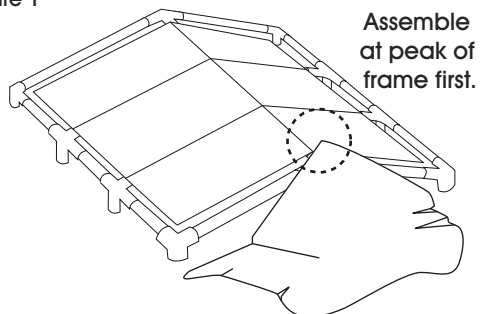

Inside view of hook and loop

ULINE H-8668

**PAREDES LATERALES PARA
CARPA DE ALTA CALIDAD**

800-295-5510

uline.mx

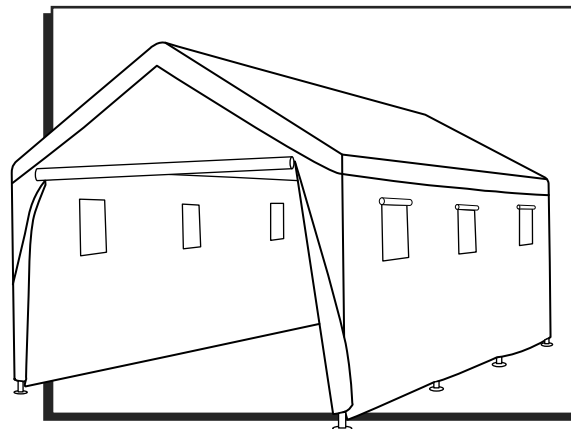

PARTES

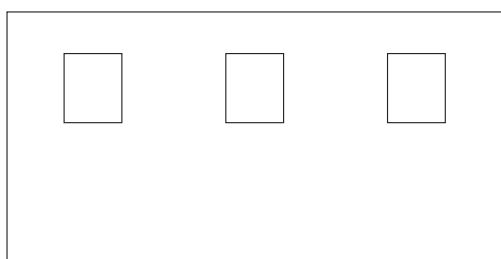

2 Paredes Laterales

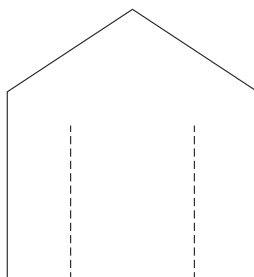

1 Pared Frontal

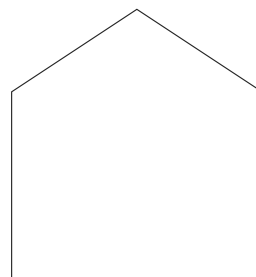

1 Pared Posterior



28 Correas Elásticas
con Esfera

ENSAMBLE

1. Desdoble la pared posterior, pared frontal y cada pared lateral.
2. Encuentre las tiras de gancho y felpa para sujetar en un lado largo de una pared lateral. Coloque estas tiras en el tubo superior de la carpa envolviéndolas sobre los postes de perímetro. (Vea Diagrama 1)
3. Repita con la segunda pared lateral, pared posterior y pared frontal.
4. Luego de conectar la parte superior de las paredes laterales e instalar los tubos de las patas en los conectores (vea las instrucciones de la carpa de alta calidad H-8667) en el perímetro de la carpa, use correas elásticas con esfera para conectar el extremo de cada pared lateral a cada esquina.

Diagrama 1

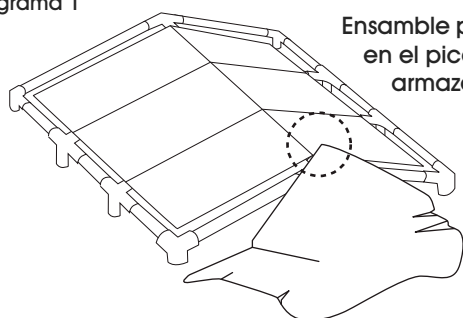

Ensamble primero
en el pico del
armazón.

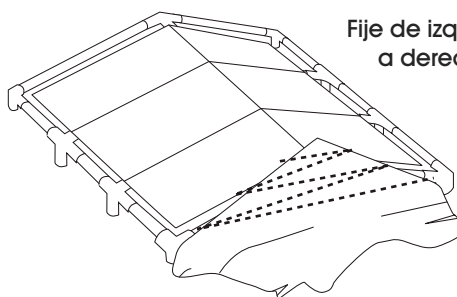

Fije de izquierda
a derecha.

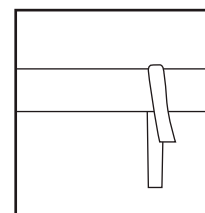

Vista interior del
gancho y felpa

ULINE H-8668
PAROIS LATÉRALES
POUR ABRI DE LUXE

1-800-295-5510
 uline.ca

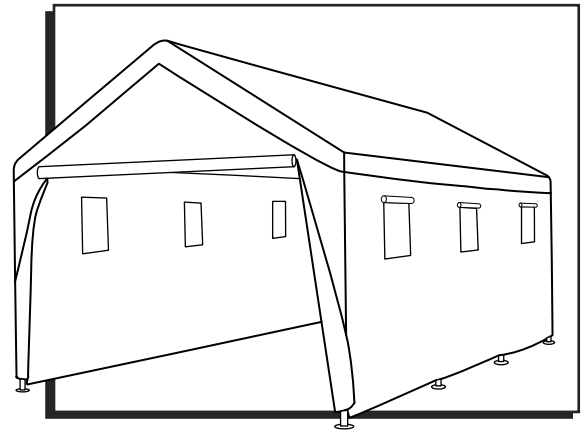

PIÈCES

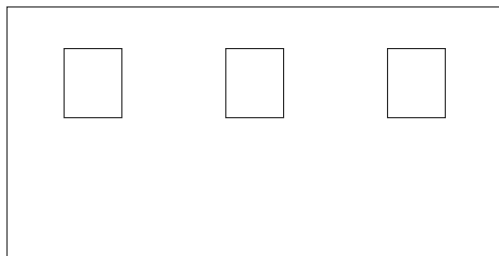

Paroi latérale x 2

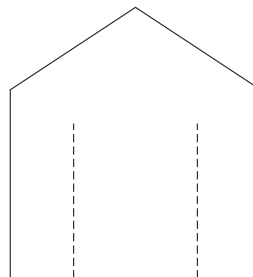

Paroi avant x 1

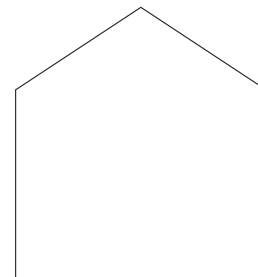

Paroi arrière x 1



Sangle élastique à
 boule x 28

MONTAGE

- Dépliez les parois arrière et avant et les deux parois latérales.
- Repérez les bandes de fixation autoagrippantes sur le long d'une des parois latérales. Placez les bandes sur le tuyau supérieur de l'abri en les enroulant autour des poteaux. (Voir Figure 1)
- Répétez l'étape pour la seconde paroi latérale, la paroi arrière et la paroi avant.
- Après avoir relié le haut des parois latérales et après avoir installé les tuyaux des pieds dans les raccords (consultez les instructions de l'abri de luxe H-8667) sur le périmètre de l'abri, utilisez les sangles élastiques à boule pour relier l'extrémité de chacune des parois latérales à chacun des coins.

Figure 1

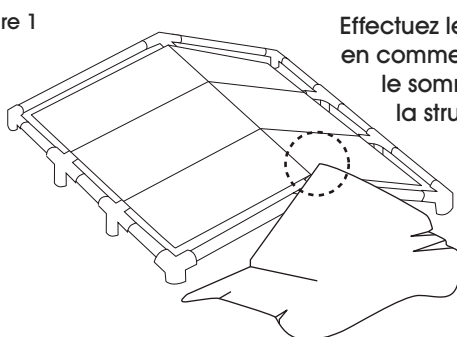

Effectuez le montage en commençant par le sommet de la structure.

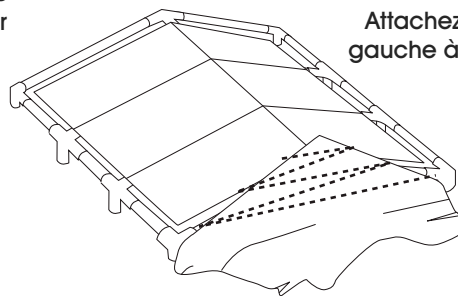

Attachez de gauche à droit.

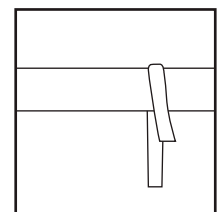

Vue intérieure de la bande autoagrippante