

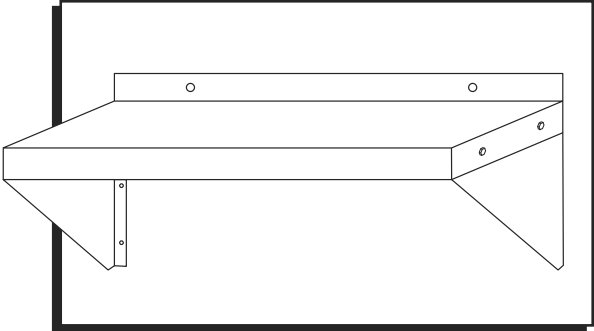

H-7498, H-7499  
H-7500

# SOLID STAINLESS STEEL WALL MOUNT SHELVING

1-800-295-5510  
uline.com



## TOOLS NEEDED



Cordless Drill



1/4" Drill Bit



10mm Wrench

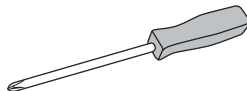

Phillips Screwdriver

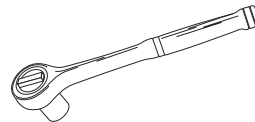

10mm Socket Wrench



Step Ladder  
(Optional)

## PARTS

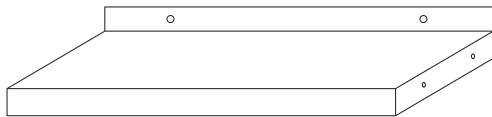

Shelf x 1

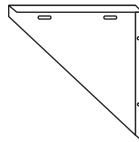

Left Shelf Support x 1

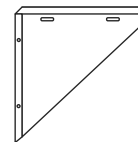

Right Shelf Support x 1

**WALL-MOUNT HARDWARE KIT**

Anchor x 6  
(x 7 for 60")

Screw x 6  
(x 7 for 60")



Phillips Head  
Bolt x 4



Acorn Nut x 4



Washer x 4



Lock Washer x 4

## INSTALLATION

Attach left and right shelf supports to shelf using bolt, lock washer, washer and acorn nut. Insert bolt through the shelf and shelf support holes and tighten acorn nut using a 10 mm wrench. (See Figure 1)

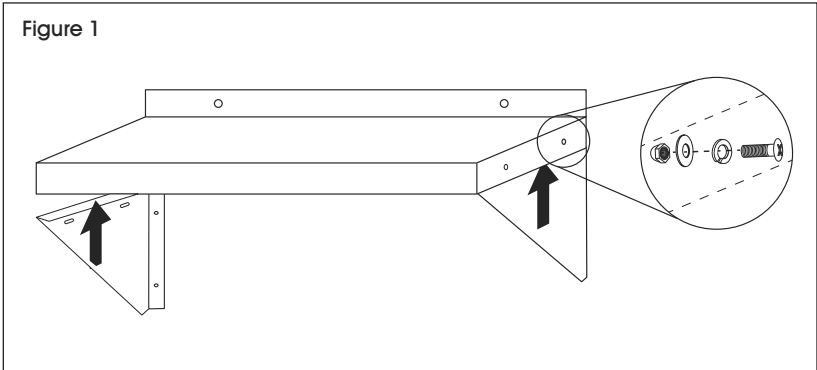

# INSTALLATION CONTINUED

## 36 AND 48" INSTALLATION

Mark hole where screws are to be located. Drill holes using 1/4" drill bit. Mount shelf to wall with six anchors and six screws using a Phillips screwdriver. (See Figure 2)

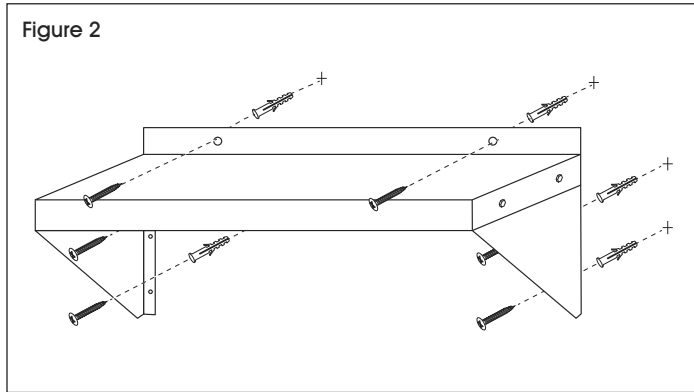

## 60" INSTALLATION

Mark holes where screws are to be located. Drill holes using 1/4" drill bit. Mount shelf to wall with seven screws and seven anchors using a Phillips screwdriver. (See Figure 3)

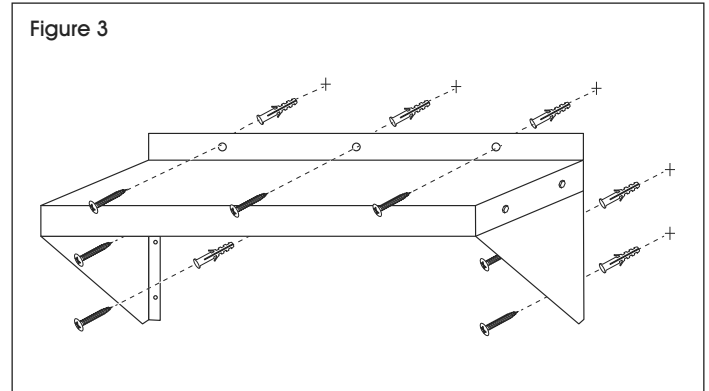



H-7498, H-7499  
H-7500

# ESTANTERÍA DE ACERO INOXIDABLE SÓLIDA PARA PARED

800-295-5510  
uline.mx

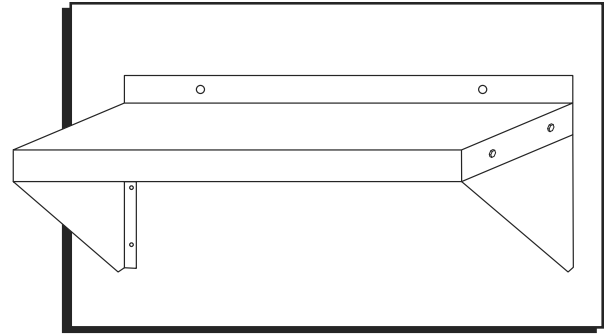

## HERRAMIENTAS NECESARIAS



Taladro Inalámbrico



Broca de 1/4"



Llave de 10mm

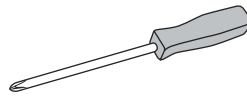

Desarmador de Cruz

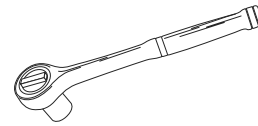

Llave de Dado de 10mm



Escalera (Opcional)

## PARTES

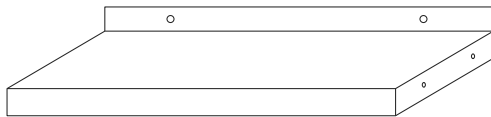

1 Repisa

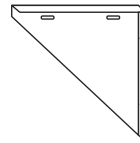

1 Soporte Izquierdo para Repisa

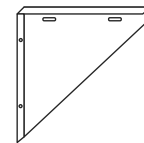

1 Soporte Derecho para Repisa



4 Pernos con Cabeza de Cruz



4 Tuercas con Punta de Bellota



4 Rondanas



4 Rondanas de Bloqueo

## INSTALACIÓN

Fije los soportes para repisas izquierdo y derecho usando perno, rondana de bloqueo, rondana y tuerca con punta de bellota. Inserte el perno a través de los orificios de la repisa y los soportes para repisa y ajuste la tuerca con punta de bellota usando una llave de 10 mm. (Vea Diagrama 1)

Diagrama 1

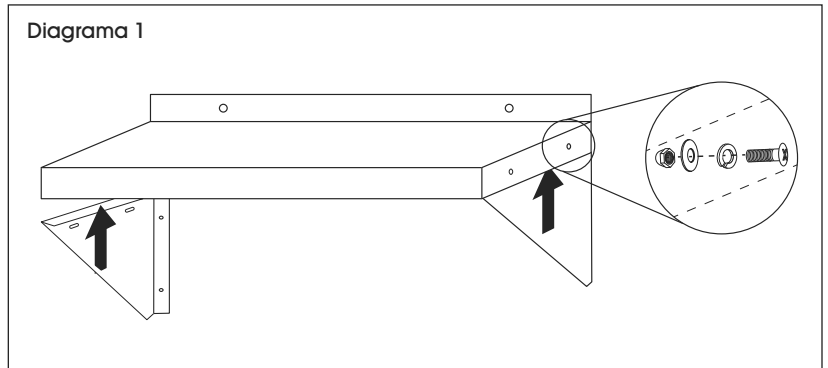

## CONTINUACIÓN DE INSTALACIÓN

### INSTALACIÓN PARA 36 Y 48"

Marque los orificios en los que se colocarán los tornillos. Taladree los orificios utilizando broca de 1/4". Instale la repisa en la pared con seis anclajes y seis tornillos utilizando un desarmador de cruz. (Vea Diagrama 2)

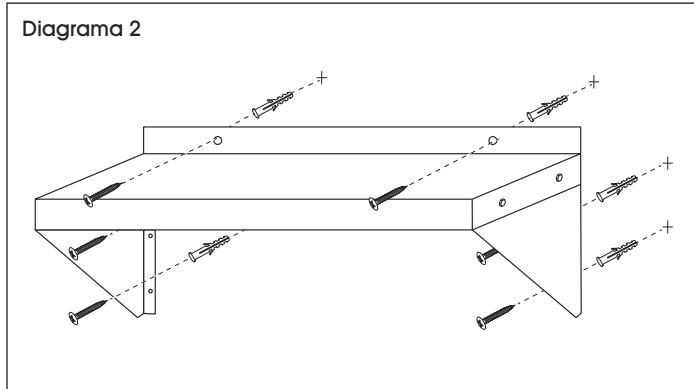

### INSTALACIÓN PARA 60"

Marque los orificios en los que los tornillos se colocarán. Taladree orificios utilizando broca de 1/4". Instale la repisa en la pared con siete anclajes y siete tornillos utilizando un desarmador de cruz. (Vea Diagrama 3)

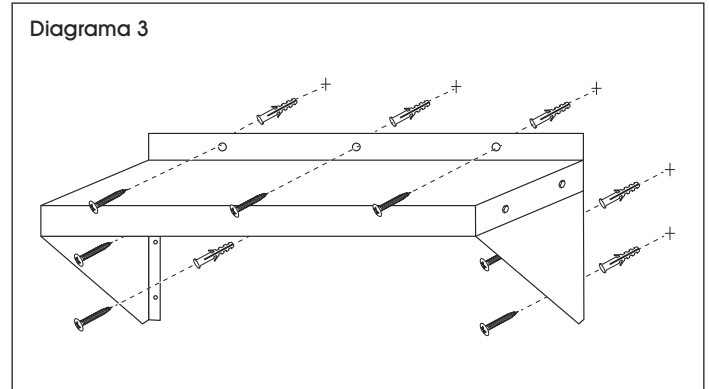



H-7498, H-7499  
H-7500

1-800-295-5510  
uline.ca

# RAYONNAGE À FIXATION MURALE EN ACIER INOXYDABLE MASSIF

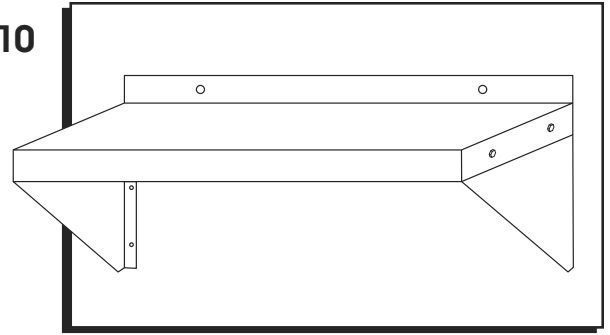

## OUTILS REQUIS



Perceuse sans fil



Mèche de perceuse de 1/4 po

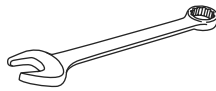

Clé de 10 mm

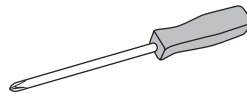

Tournevis cruciforme

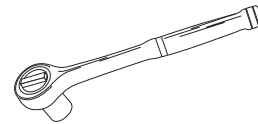

Clé à douille de 10 mm



Escabeau (facultatif)

## PIÈCES

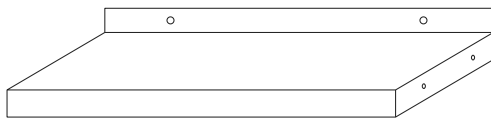

Tablette x 1

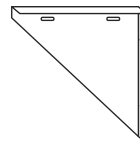

Console de tablette gauche x 1

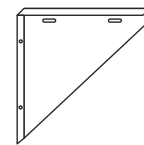

Console de tablette droite x 1

### MATÉRIEL D'INSTALLATION POUR FIXATION MURALE

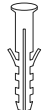

Ancrage x 6  
(x 7 pour tablette de 60 po)

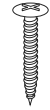

Vis x 6  
(x 7 pour tablette de 60 po)



Boulon cruciforme x 4



Écrou borgne x 4



Rondelle x 4



Rondelle de blocage x 4

## INSTALLATION

Fixez les consoles gauche et droite à la tablette à l'aide d'un boulon, d'une rondelle de blocage, d'une rondelle et d'un écrou borgne. Insérez le boulon à travers la tablette et les trous de la console, puis serrez l'écrou borgne à l'aide d'une clé de 10 mm. (Voir Figure 1)

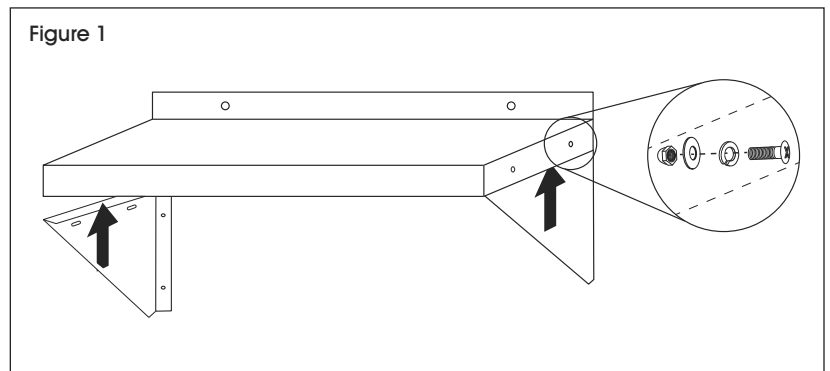

## INSTRUCTIONS SUITE

### INSTALLATION DE TABLETTE DE 36 PO ET 48 PO

Marquez l'emplacement des trous à percer. Percez les trous en utilisant une mèche de perceuse de 1/4 po. Fixez la tablette au mur en utilisant six ancres, six vis et un tournevis cruciforme. (Voir Figure 2)

Figure 2

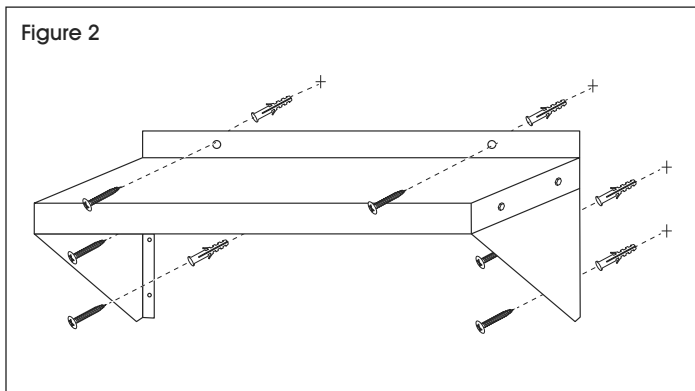

### INSTALLATION DE TABLETTE DE 60 PO

Marquez l'emplacement des trous à percer. Percez les trous en utilisant une mèche de perceuse de 1/4 po. Fixez la tablette au mur en utilisant sept ancres, sept vis et un tournevis cruciforme. (Voir Figure 3)

Figure 3

