

ULINE H-7268, H-7269 PLASTIC FIRE EXTINGUISHER CABINET

1-800-295-5510
uline.com

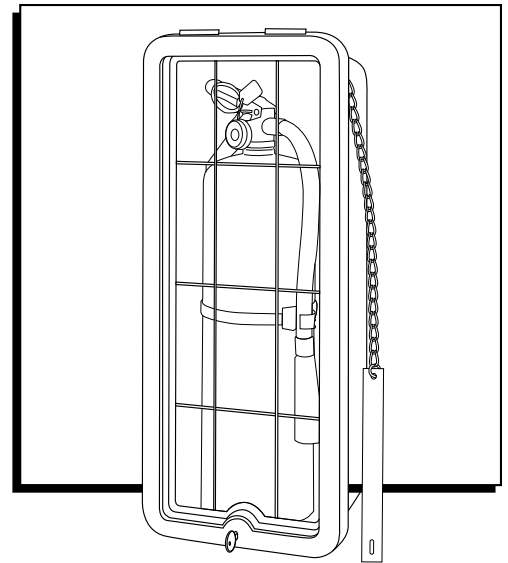

PARTS

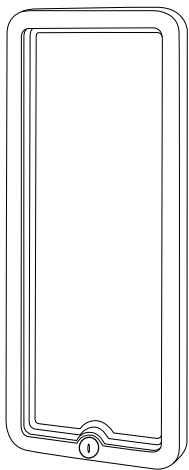

Frame x 1

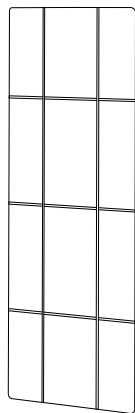

Break Panel x 1

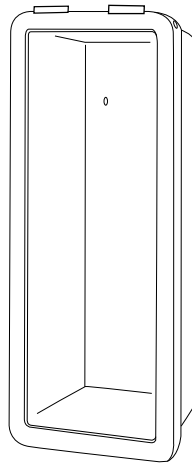

Cabinet x 1



Key x 1



Cotter Ring x 1
(comes attached
to Breaker Bar)

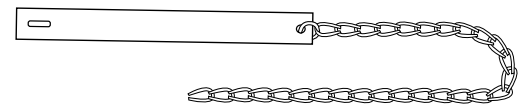

Breaker Bar x 1

ASSEMBLY

ATTACHING BREAKER BAR TO CABINET

1. Remove cotter ring (key ring) from free end of chain.
2. Insert chain through outside of hole on upper right flange of the body of the cabinet. (See Figure 1)
3. Place cotter ring back on end of chain inside cabinet to hold breaker bar in place.

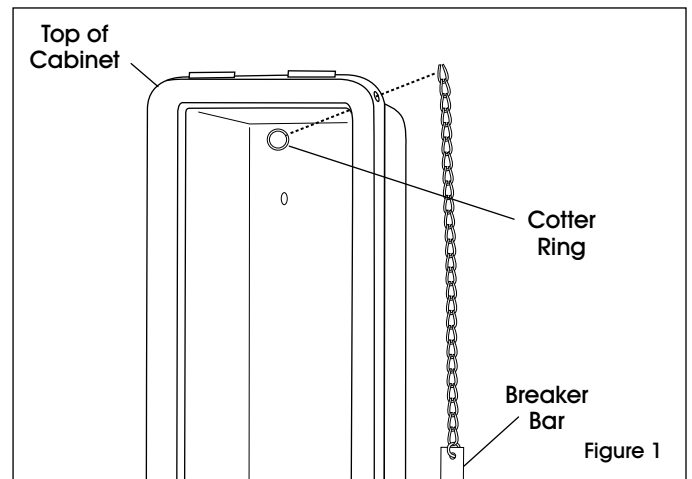

ULINE H-7268, H-7269

GABINETE DE PLÁSTICO PARA EXTINTORES

800-295-5510
uline.mx

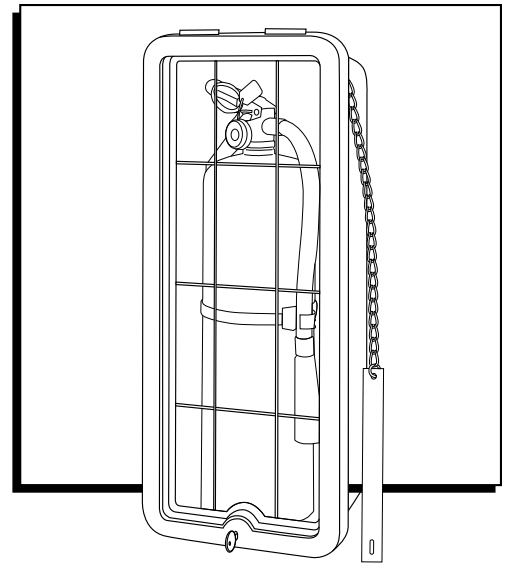

PARTES

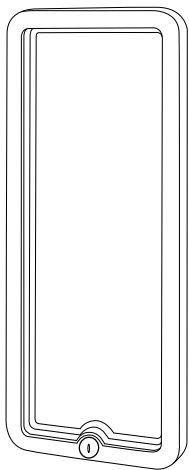

1 Marco

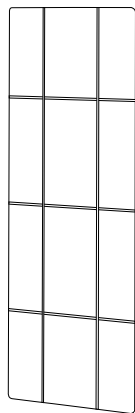

1 Panel Rompible

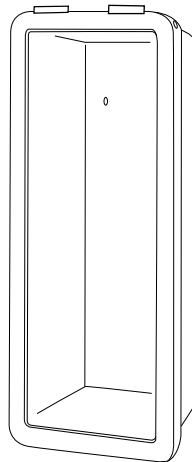

1 Gabinete



1 Llave



1 Anillo de Chaveta
(va unido a la Barra)

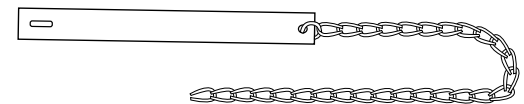

1 Barra

ENSAMBLE

CÓMO FIJAR LA BARRA AL GABINETE

1. Retire el anillo de chaveta (llavero) del extremo libre de la cadena.
2. Inserte la cadena a través del exterior del orificio en la parte superior derecha del reborde del gabinete. (Vea Diagrama 1)
3. Coloque de nuevo el anillo de chaveta en el interior del gabinete en el extremo de la cadena para mantener la barra en su lugar.

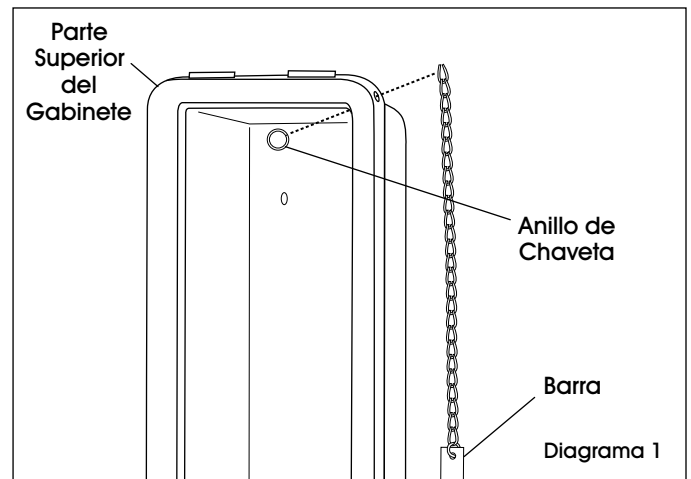

ULINE H-7268, H-7269

ARMOIRE POUR EXTINCTEUR EN PLASTIQUE

1-800-295-5510
uline.ca

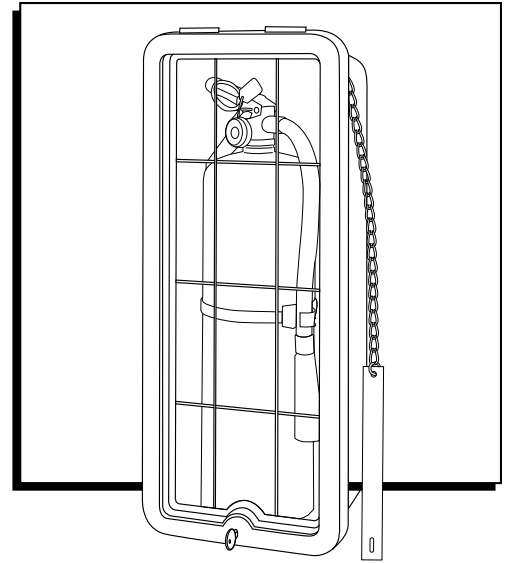

PIÈCES

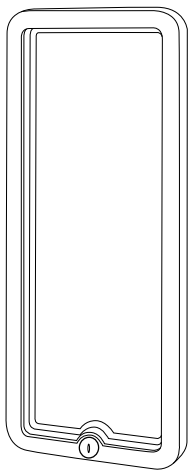

Cadre x 1

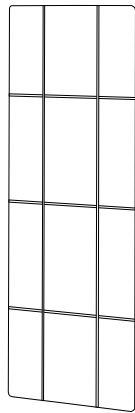

Barre de rupture x 1

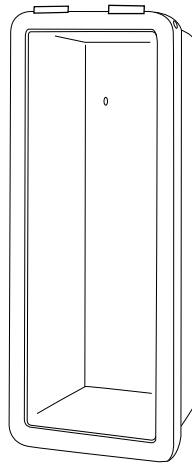

Armoire x 1



Clé x 1



Anneau rainuré x 1
(attaché à la barre
de rupture)

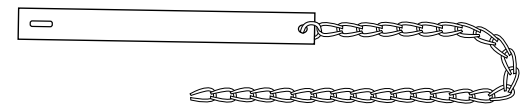

Barre de rupture x 1

ASSEMBLAGE

FIXER LA BARRE DE RUPTURE À L'ARMOIRE

1. Enlevez l'anneau rainuré de l'extrémité de la chaîne.
2. Insérez la chaîne, à partir de l'extérieur, à travers le trou sur le haut de la bride droite du cadre de l'armoire. (Voir Figure 1)
3. Remettez l'anneau rainuré sur l'extrémité de la chaîne à l'intérieur de l'armoire pour maintenir la barre de rupture en place.

