

# ULINE H-7234 METAL TERRACE RECEPTACLE

1-800-295-5510  
uline.com

## TOOL NEEDED



3/16" Allen Wrench x 1  
(Included)

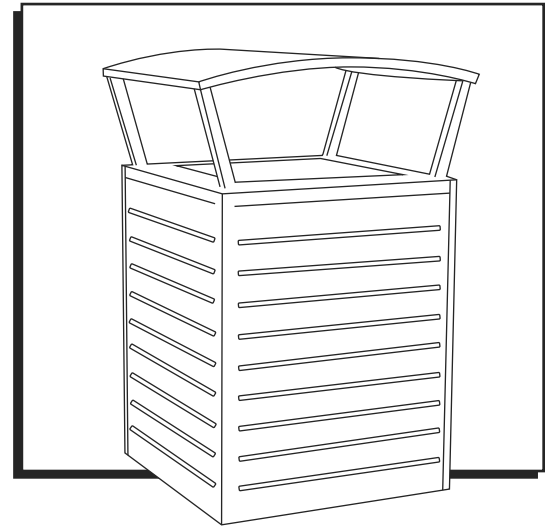

## PARTS

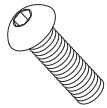

5/16-18 x 1 1/4" Cap Screw x 4

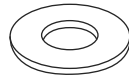

Flat Washer x 4

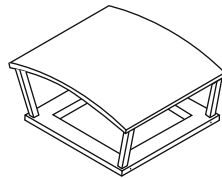

Lid x 1

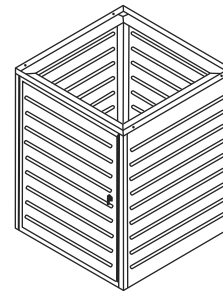

Base x 1

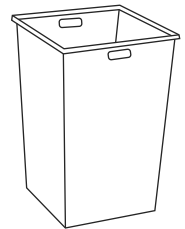

32 Gallon Rigid Liner x 1

## ASSEMBLY

1. Verify all parts are present before beginning. Hardware is located with the lid.
2. Place the lid on the top of the base aligning the predrilled holes. (See Figure 1)
3. From the outside of the base fasten one flat washer and one cap screw through the base into the lid until tight. Repeat for all four corners. (See Figure 2)

Figure 1

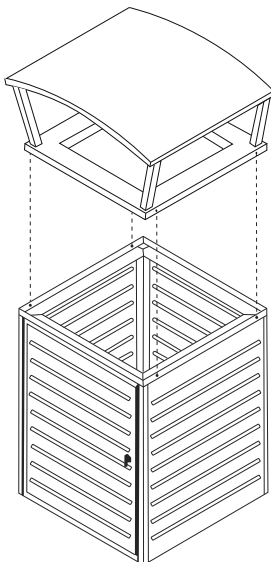
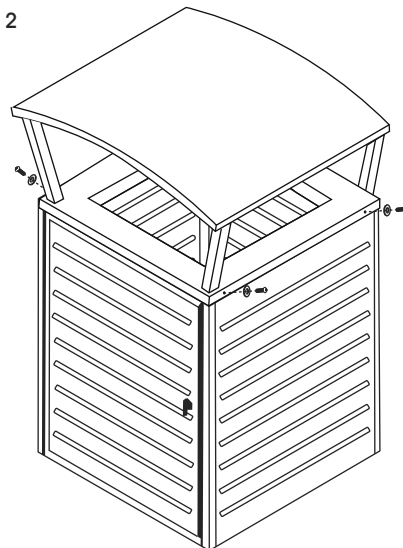

Figure 2



**ULINE** H-7234

# BOTE DE BASURA PARA PATIOS

800-295-5510

uline.mx

## HERRAMIENTA NECESARIA



1 Llave Allen de 3/16"  
(incluida)

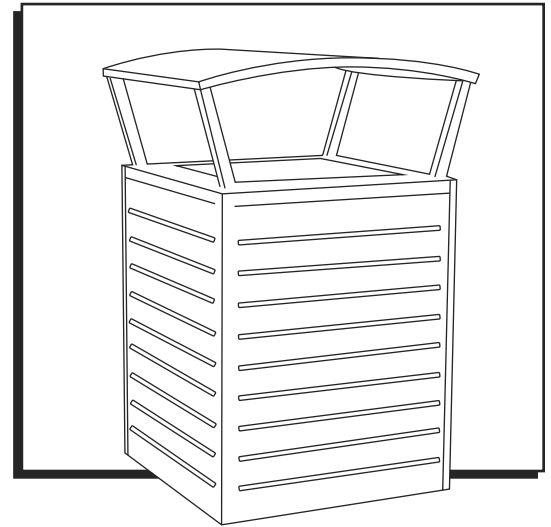

## PARTES

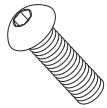

4 Tornillos de Cabeza  
5/16-18 x 1/4"

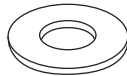

4 Rondanas Planas

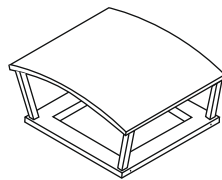

1 Tapa

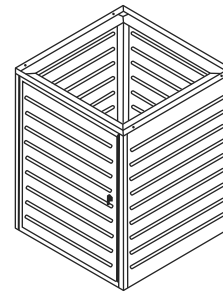

1 Base

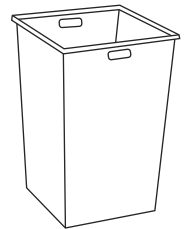

1 Revestimiento Rígido de  
32 Galones

## ENSAMBLE

1. Revise que tenga todas las partes antes de empezar. La tornillería está localizada en la tapa.
2. Coloque la tapa por encima de la base alineándola con los orificios pretaladrados. (Vea Diagrama 1)
3. Desde el exterior de la base, sujete una rondana plana y un tornillo de cabeza a la tapa a través de la base hasta que queden apretados. Repita para las cuatro esquinas. (Vea Diagrama 2)

Diagrama 1



Diagrama 2



**ULINE** H-7234

# POUBELLE DE TERRASSE EN MÉTAL

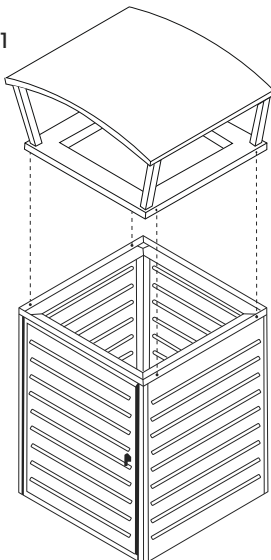
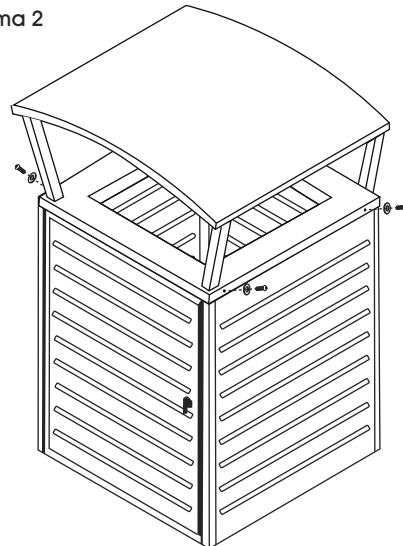
1-800-295-5510

uline.ca

## OUTIL REQUIS

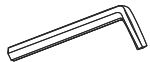

Clé Allen de 3/16 po x 1  
(incluse)

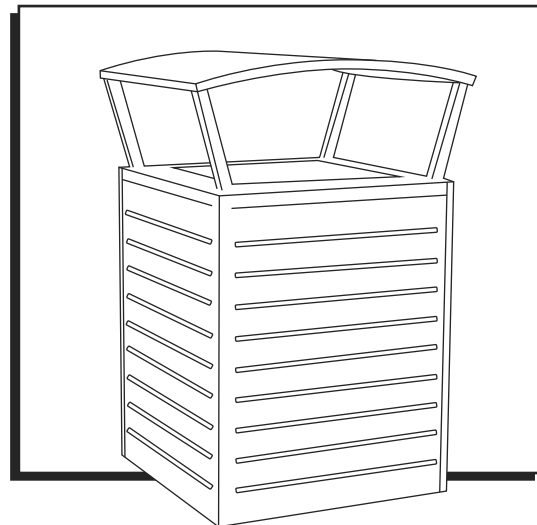

## PIÈCES

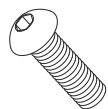

Vis d'assemblage de  
5/16-18 x 1 1/4 po x 4



Rondelle plate x 4

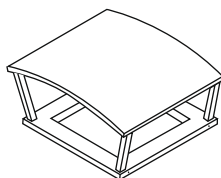

Couvercle x 1

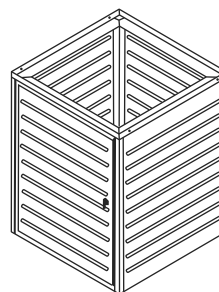

Base x 1

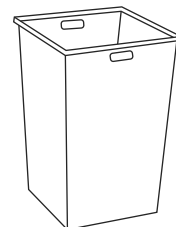

Contenant rigide de  
32 gallons x 1

## MONTAGE

1. Assurez-vous que toutes les pièces sont présentes avant de commencer. Le matériel d'installation se trouve avec le couvercle.
2. Placez le couvercle sur la base en alignant les trous prépercés. (Voir Figure 1)
3. Enfilez une rondelle plate et une vis d'assemblage à travers l'extérieur de la base et fixez le tout au couvercle en serrant bien. Répétez la procédure pour les autres coins. (Voir Figure 2)

Figure 1

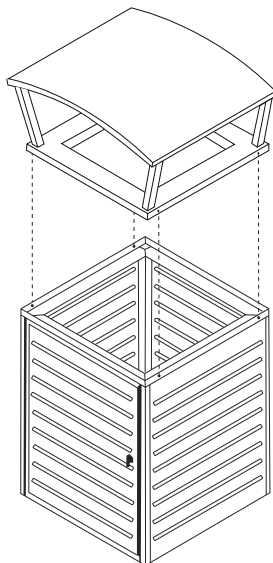

Figure 2

