

**ULINE** H-6819, H-6820  
H-6821  
**STAINLESS STEEL  
WIRE CARTS**

1-800-295-5510  
uline.com

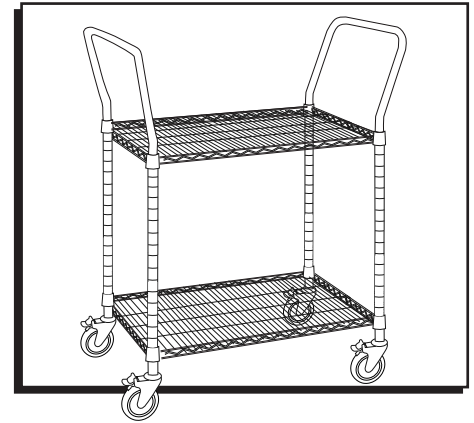

**TOOL NEEDED**



**PARTS**

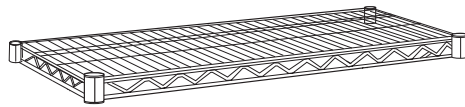
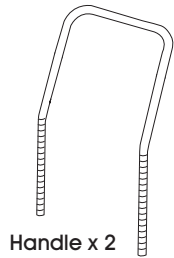

**ASSEMBLY**

1. Slide top shelf up the posts one end at a time, handles facing out. (See Figure 1)
2. Snap the interlocking pieces of a shelf support (wide end down) around the post at the highest groove where shelf is to be located. Slide the support up or down until it snaps into the groove. (See Figure 2)
3. After snapping together all of the shelf supports at the proper height, slide the shelf down over the supports to secure the shelf. (See Figure 3)
4. Repeat steps 1 through 3 to attach the remaining shelf in the same manner.

 **NOTE:** Make sure shelf supports are located under the shelf.

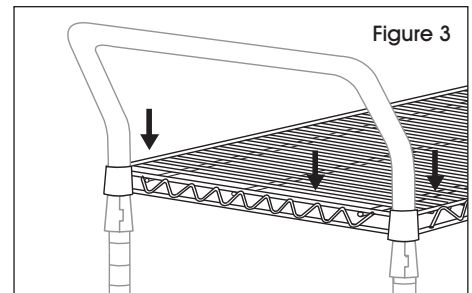
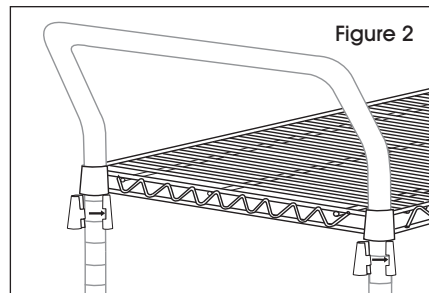
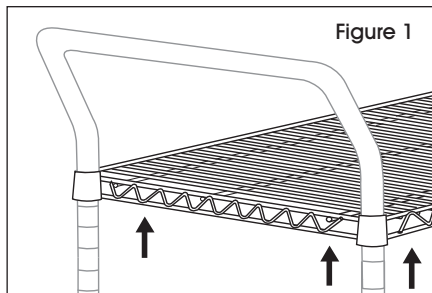

**CASTER INSTALLATION**

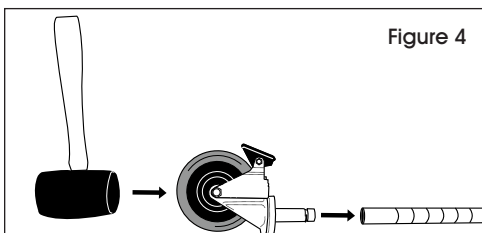

1. Make sure post is positioned as shown. (See Figure 4)
2. Engage the wheel brakes to keep casters from spinning during installation. Use a rubber mallet to tap caster stem into posts. (See Figure 4)



H-6819, H-6820  
H-6821

# CARRITOS DE ALAMBRE DE ACERO INOXIDABLE

800-295-5510  
uline.mx

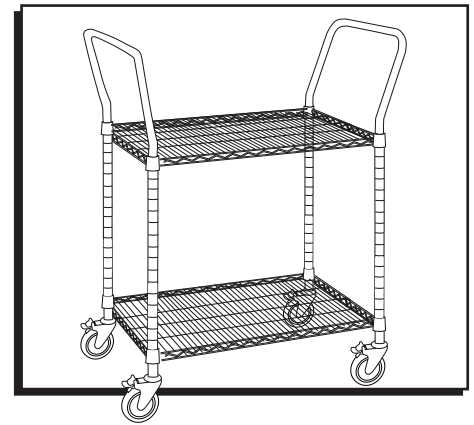

## HERRAMIENTA NECESARIA

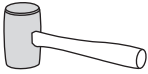

Mazo de Caucho

## PARTES

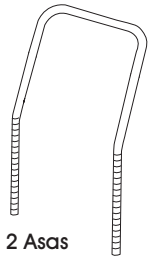

2 Asas

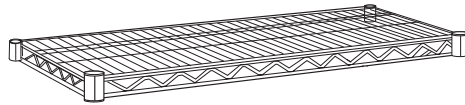

2 Repisas



8 Soportes para Repisa



4 Ruedas

## ENSAMBLE

1. Deslice la repisa superior hacia arriba por los postes, un extremo a la vez, con las asas viendo hacia afuera. (Vea Diagrama 1)
2. Trabe las partes entrelazables de un soporte para repisa (con la parte ancha hacia abajo) al rededor del poste en la ranura más alta dónde desee colocar la repisa. Deslice el soporte hacia arriba o abajo hasta que se trabe en la ranura. (Vea Diagrama 2)
3. Después de trabar todos los soportes para repisa a la altura apropiada, deslice la repisa hacia abajo sobre los soportes para asegurarla. (Vea Diagrama 3)
4. Repita los pasos 1 al 3 para asegurar la repisa restante de la misma manera.

 **NOTA:** Asegúrese que los soportes para repisa estén colocados debajo de la misma.

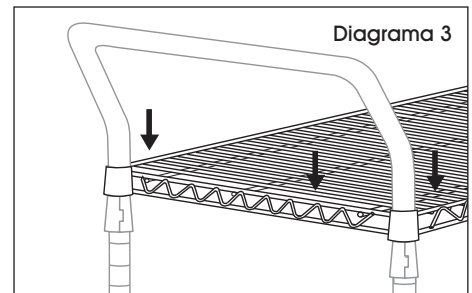
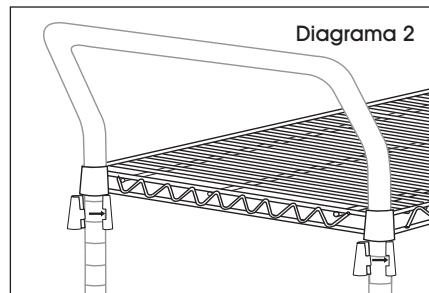
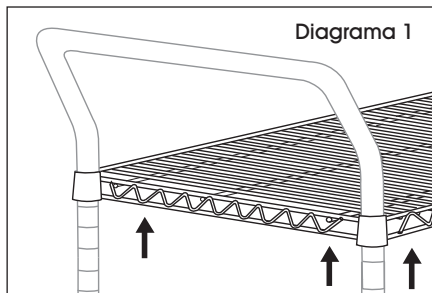

## INSTALACIÓN DE LAS RUEDAS

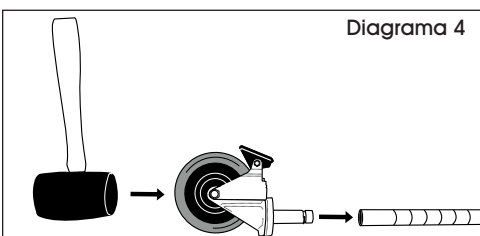

1. Asegúrese que el poste esté colocado como se muestra. (Vea Diagrama 4)
2. Trabe los frenos de las llantas para evitar que giren durante la instalación. Utilice un mazo de caucho para insertar el vástago de las ruedas en los postes. (Vea Diagrama 4)

# CHARIOTS EN FIL D'ACIER INOXYDABLE

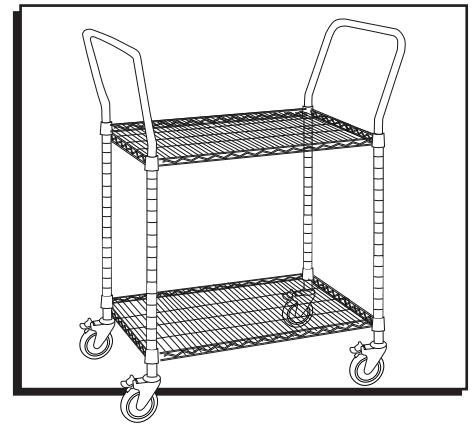

## OUTILS REQUIS

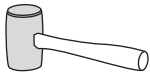

Maillet en caoutchouc

## PIÈCES

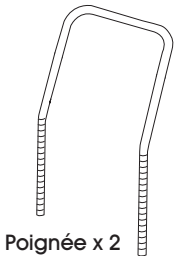

Poignée x 2

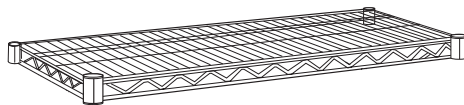

Tablette x 2



Ensemble de support  
de tablette x 8



Roulette x 4

## MONTAGE

1. Faites glisser la tablette supérieure vers le haut sur les montants, une extrémité à la fois, poignées vers l'extérieur. (Voir Figure 1)
2. Enclenchez les pièces emboîtables d'un support de tablette (l'extrémité la plus large vers le bas) autour du montant, au niveau de la rainure la plus élevée à l'endroit où la tablette doit être placée. Faites glisser le support vers le haut ou vers le bas jusqu'à ce qu'il s'enclenche dans la rainure. (Voir Figure 2)
3. Lorsque tous les supports de tablette sont enclenchés à la bonne hauteur, faites glisser la tablette vers le bas sur les supports pour fixer la tablette. (Voir Figure 3)
4. Répétez les étapes 1 à 3 pour fixer la tablette restante de la même manière.



**REMARQUE :** Assurez-vous que les supports de tablette sont situés sous la tablette.

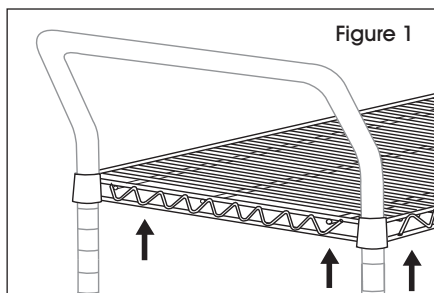

Figure 1

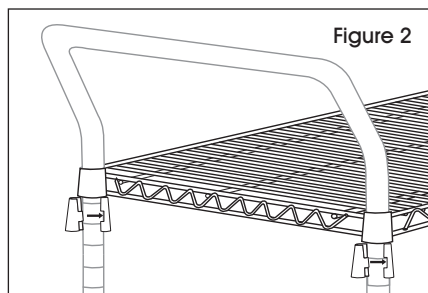

Figure 2

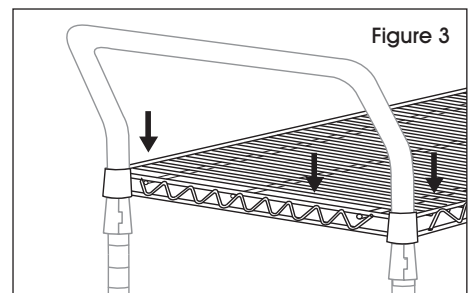

Figure 3

## INSTALLATION DES ROULETTES

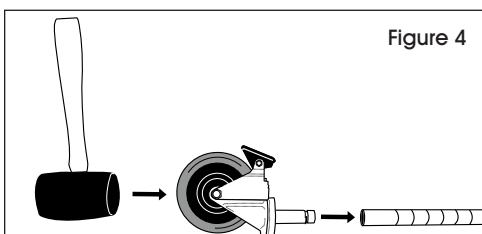

Figure 4

1. Assurez-vous que le montant est placé comme illustré. (Voir Figure 4)
2. Enclenchez le frein des roulettes pour les empêcher de tourner pendant l'installation. Utilisez un maillet en caoutchouc pour insérer la tige des roulettes dans les montants. (Voir Figure 4)