

# ULINE H-6785, H-6786 H-6787, H-6788 BLACK HEAVY-DUTY WIRE CARTS

1-800-295-5510  
uline.com

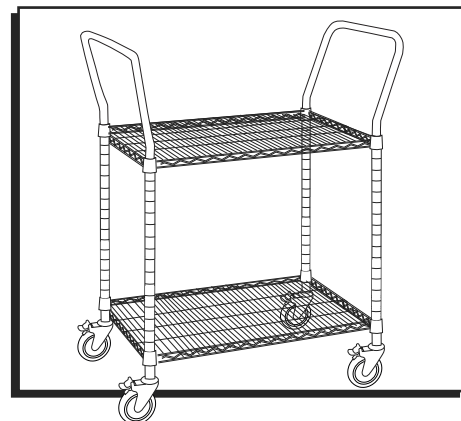

## TOOL NEEDED



## PARTS

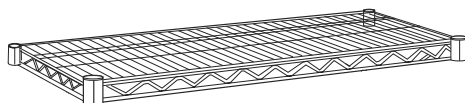
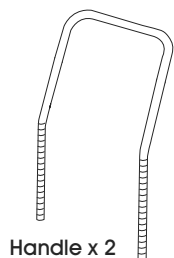

## ASSEMBLY

1. Slide top shelf up the posts one end at a time, handles facing out. (See Figure 1)
2. Snap the interlocking pieces of a shelf support (wide end down) around the post at the highest groove where shelf is to be located. Slide the support up or down until it snaps into the groove. (See Figure 2)
3. After snapping together all of the shelf supports at the proper height, slide the shelf down over the supports to secure the shelf. (See Figure 3)
4. Repeat steps 1 through 3 to attach the remaining shelf in the same manner.

 **NOTE:** Make sure shelf supports are located under the shelf.

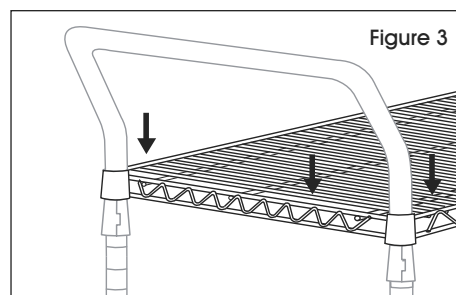
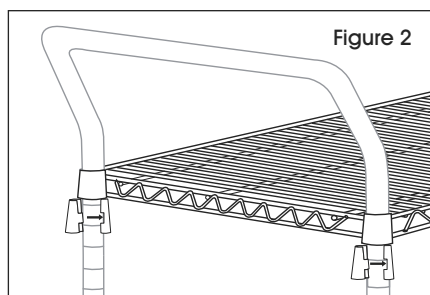
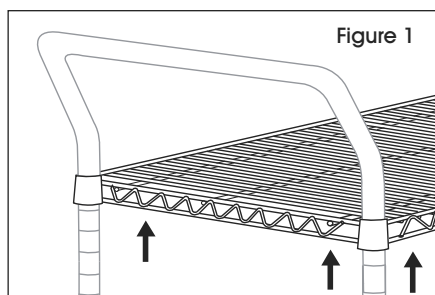

## CASTER INSTALLATION

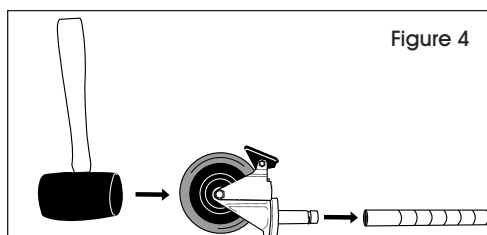

1. Make sure post is positioned as shown. (See Figure 4)
2. Engage the wheel brakes to keep casters from spinning during installation. Use a rubber mallet to tap caster stem into posts. (See Figure 4)

# CARRITOS DE ALAMBRE DE USO PESADO NEGROS

## HERRAMIENTA NECESARIA

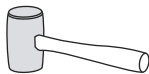

Mazo de Hule

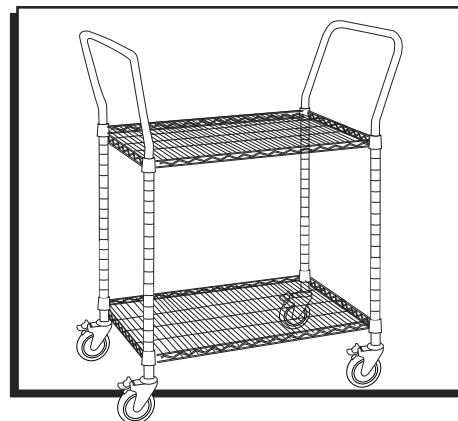

## PARTES

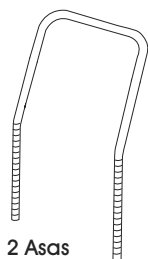

2 Asas

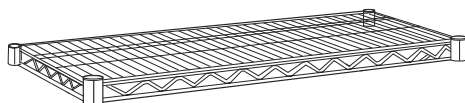

2 Repisas



8 Sets de Soportes para Repisas



4 Ruedas

## ENSAMBLE

1. Deslice la repisa superior por los postes hacia arriba uno a uno, con las asas mirando hacia afuera. (Vea Diagrama 1)
2. Coloque a presión las piezas interconectadas de un soporte de repisa (extremo amplio hacia abajo) alrededor del poste en la ranura más alta, en donde se ubicará la repisa. Deslice el soporte hacia arriba o abajo hasta que se inserte a presión en la ranura. (Vea Diagrama 2)
3. Tras unir todos los soportes para las repisas a la altura adecuada, deslice la repisa hacia abajo por encima de los soportes para fijar la repisa. (Vea Diagrama 3)
4. Repita los pasos 1 al 3 para fijar la repisa restante de la misma manera.



**NOTA:** Asegúrese de que los soportes para las repisas estén colocados debajo de la repisa.



Diagrama 1



Diagrama 2

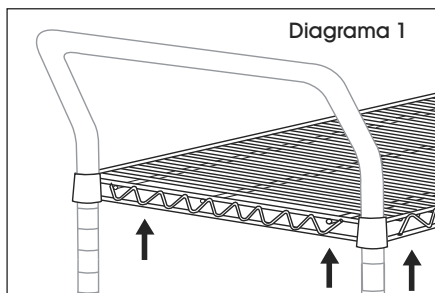

Diagrama 3

## INSTALACIÓN DE LAS RUEDAS

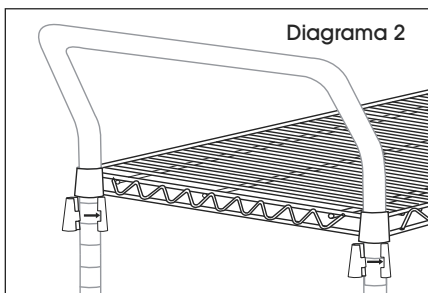

Diagrama 4

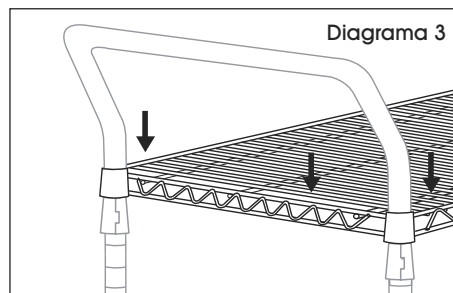
1. Asegúrese de que el poste esté posicionado como se indica. (Vea Diagrama 4)
2. Active los frenos para evitar que las ruedas se giren durante la instalación. Utilice un mazo de hule para introducir los vástagos de las ruedas en los postes. (Vea Diagrama 4)

**ULINE** H-6785, H-6786  
H-6787, H-6788

# CHARIOTS ROBUSTES EN FIL DE MÉTAL – NOIR

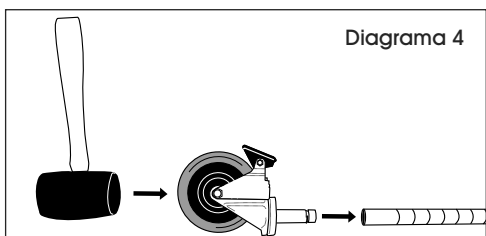
1-800-295-5510  
uline.ca

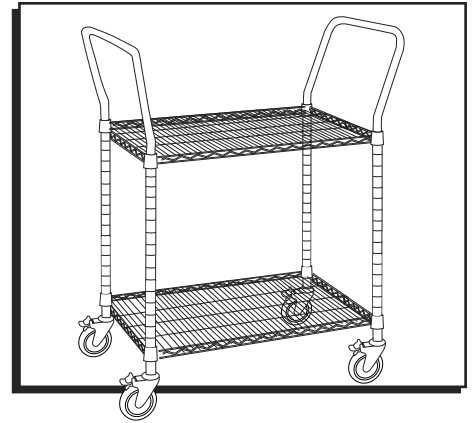

## OUTILS REQUIS

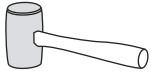

Maillet en caoutchouc

## PIÈCES

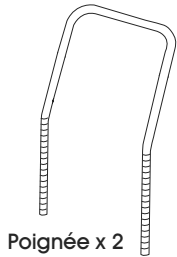

Poignée x 2

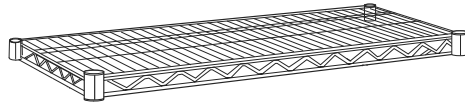

Tablette x 2



Ensemble de support de  
tablette x 8



Roulette x 4

## MONTAGE

1. Faites glisser la tablette supérieure vers le haut sur les montants, une extrémité à la fois, les poignées vers l'extérieur. (Voir Figure 1)
2. Enclenchez les pièces emboîtables d'un support de tablette (l'extrémité la plus large vers le bas) autour du montant, au niveau de la rainure la plus élevée à l'endroit où la tablette doit être placée. Faites glisser le support vers le haut ou vers le bas jusqu'à ce qu'il s'enclenche dans la rainure. (Voir Figure 2)
3. Lorsque tous les supports de tablette sont enclenchés à la bonne hauteur, faites glisser la tablette vers le bas sur les supports pour fixer la tablette. (Voir Figure 3)
4. Répétez les étapes 1 à 3 pour fixer la tablette restante de la même manière.



**REMARQUE :** Assurez-vous que les supports de tablette sont situés sous la tablette.

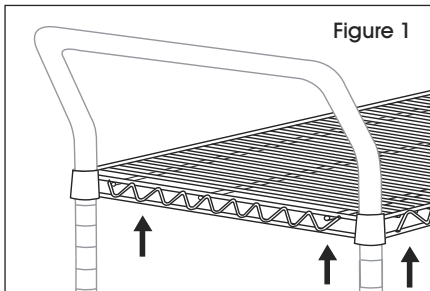

Figure 1

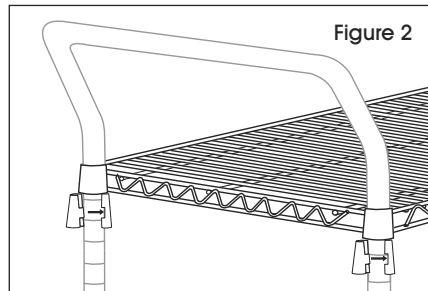

Figure 2

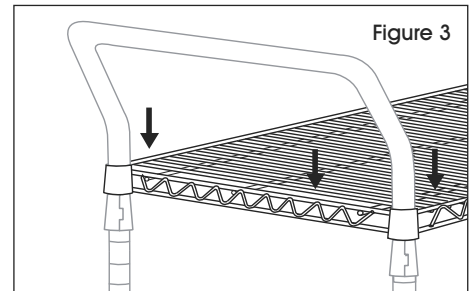

Figure 3

## INSTALLATION DES ROULETTES

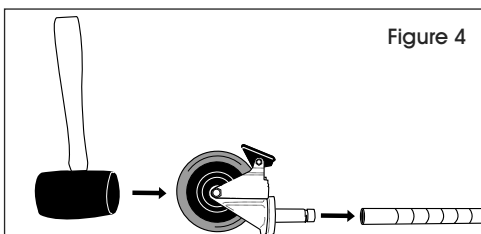

Figure 4

1. Assurez-vous que le montant est placé comme illustré. (Voir Figure 4)
2. Enclenchez le frein des roulettes pour les empêcher de tourner pendant l'installation. Utilisez un maillet en caoutchouc pour insérer la tige des roulettes dans les montants. (Voir Figure 4)