

# ULINE H-6699

## WELDING SCREEN – 6 x 4'

1-800-295-5510  
 uline.com

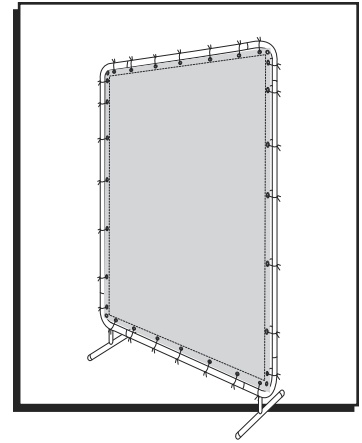

### PARTS

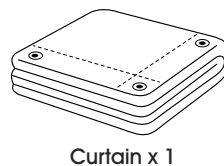
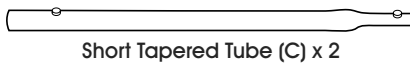
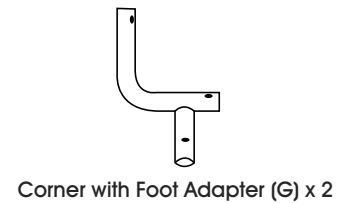
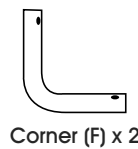
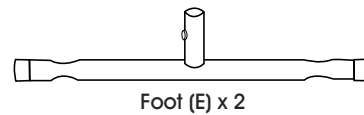
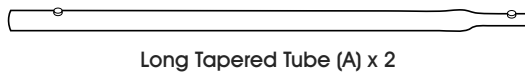

### ASSEMBLY

1. Assemble the top and bottom frames by connecting the short tapered (C) and short non-tapered (D) tubes until pins snap and lock in place.
2. Assemble the left and right frames by connecting the medium non-tapered (B) and long tapered (A) tubes until pins snap and lock in place.
3. Connect the left and right corners (F) to the top, left and right frames until pins snap and lock in place.
4. Connect the corners with foot adapter (G) to the bottom, left and right frames until pins snap and lock in place.
5. Connect the foot (E) to each corner with foot adapter (G) until pins snap and lock in place.
6. With frame assembled, begin attaching the screen to the frame using the curtain ties.

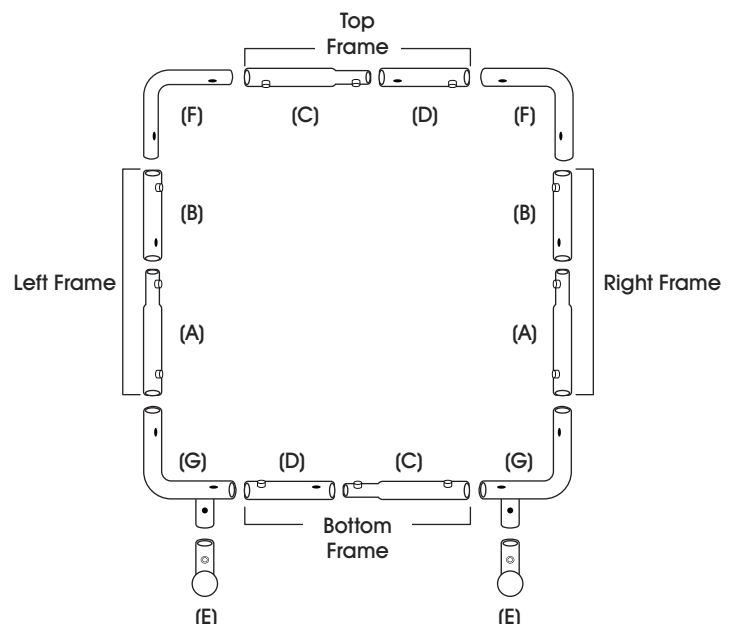

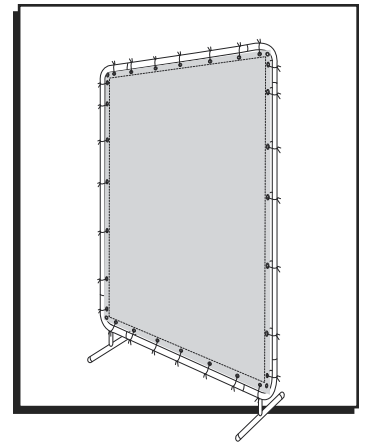
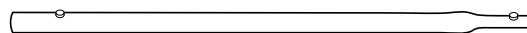
**PARTES**

2 Tubos Cónicos Largos (A)

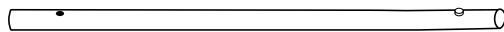

2 Tubos Medianos No Cónicos (B)

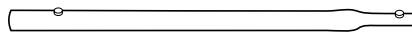

2 Tubos Cónicos Cortos (C)

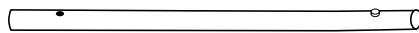

2 Tubos Cortos No Cónicos (D)

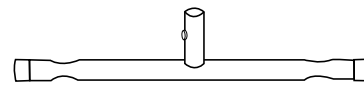

2 Patas (E)

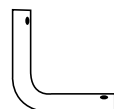

2 Esquinas (F)

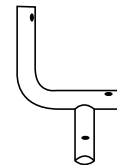
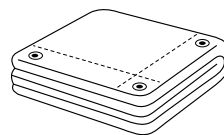
2 Esquinas con  
Adaptadores para Pata (D)

1 Cortina



25 Cinchos para Cortina

**ENSAMBLE**

1. Ensamble los armazones superior e inferior conectando los tubos cortos no cónicos (C) y los tubos cortos cónicos (D) hasta que los pasadores encajen en su lugar.
2. Ensamble los armazones izquierdo y derecho conectando los tubos medianos no cónicos (B) y los tubos cónicos largos (A) hasta que los pasadores encajen en su lugar.
3. Conecte las esquinas izquierda y derecha (F) a los armazones superior, izquierdo y derecho hasta que los pasadores encajen en su lugar.
4. Conecte las esquinas con adaptadores para pata (G) a los armazones inferior, izquierdo y derecho hasta que los pasadores encajen en su lugar.
5. Conecte la pata (E) a cada esquina con adaptador para pata (G) hasta que los pasadores encajen en su lugar.
6. Con su armazón ensamblado, comience a unir la cortina al armazón utilizando los cinchos para cortina.

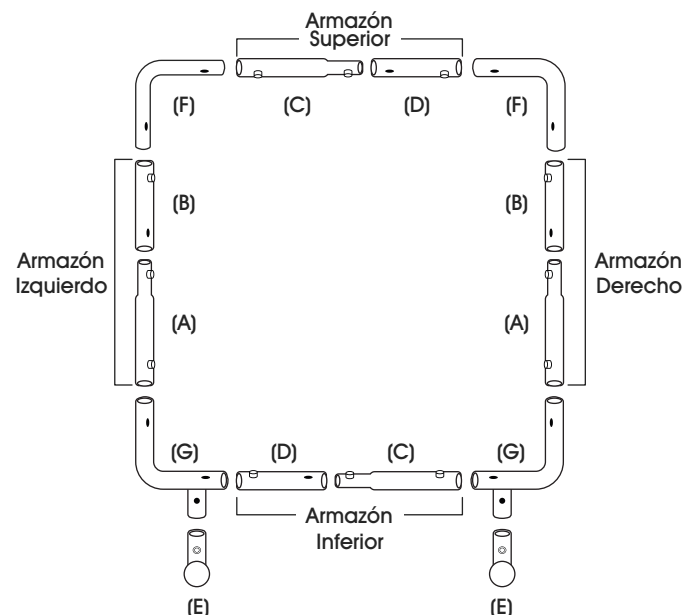

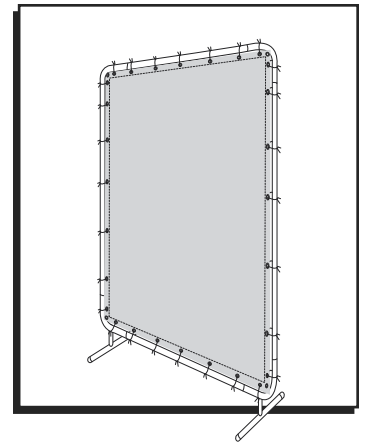
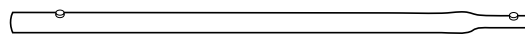
**PIÈCES**

Tube long conique (A) x 2

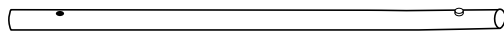

Tube moyen non conique (B) x 2

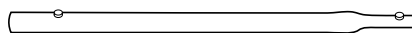

Tube court conique (C) x 2

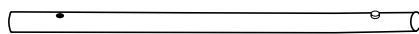

Tube court non conique (D) x 2

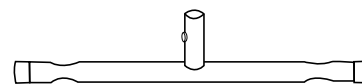
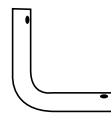
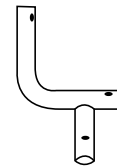
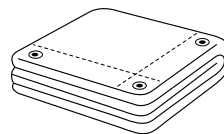
Tube de  
pied (E) x 2Tube de  
coin (F) x 2Tube de coin avec  
adaptateur de pied (G) x 2

Rideau x 1

Attache  
de rideau x 25**MONTAGE**

1. Assemblez les côtés supérieur et inférieur en rattachant les tubes courts coniques (C) aux tubes courts non coniques (D) jusqu'à ce que les goupilles se verrouillent en place.
2. Assemblez les côtés latéraux gauche et droit en rattachant les tubes moyens non coniques (B) aux tubes longs coniques (A) jusqu'à ce que les goupilles se verrouillent en place.
3. Reliez les tubes de coin gauche et droit (F) aux extrémités du côté supérieur jusqu'à ce que les goupilles se verrouillent en place.
4. Reliez les tubes de coin avec adaptateur de pied (G) aux extrémités du côté inférieur jusqu'à ce que les goupilles se verrouillent en place.
5. Reliez le tube de pied (E) à chaque tube de coin avec adaptateur de pied (G) jusqu'à ce que les goupilles se verrouillent en place.
6. Avec le montage du cadre maintenant terminé, fixez-y l'écran à l'aide des attaches de rideau.

