

# ULINE H-5730 HEAVY-DUTY STEEL DRUM DOLLY

1-800-295-5510  
uline.com

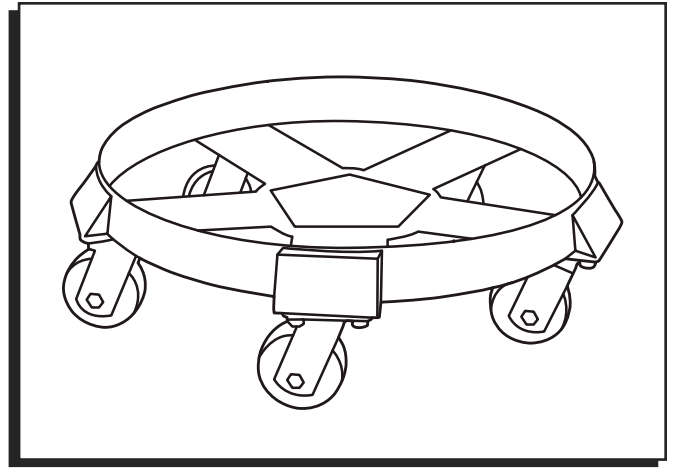

## TOOL NEEDED

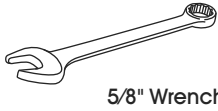

5/8" Wrench

## PARTS



Caster x 5



Lock Washer x 20

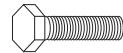

Bolt x 20



Washer x 20



Nut x 20

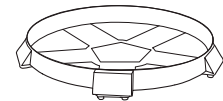

Drum Dolly Frame x 1

## ASSEMBLY

### INSTALL CASTERS

1. Turn drum dolly frame upside down.
2. Align caster with bolt holes. Insert bolt, washer, lock washer and attach with nut. (See Figure 1)
3. Tighten nuts with an 5/8" wrench.
4. Repeat for remaining casters.

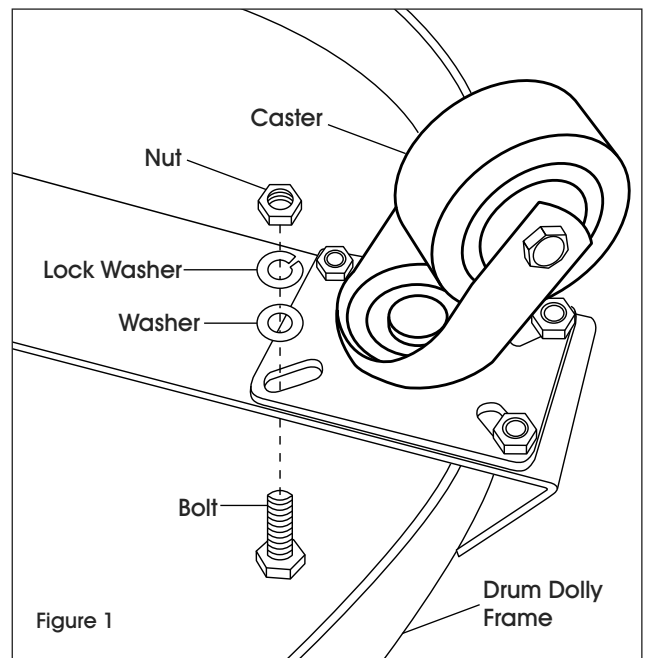
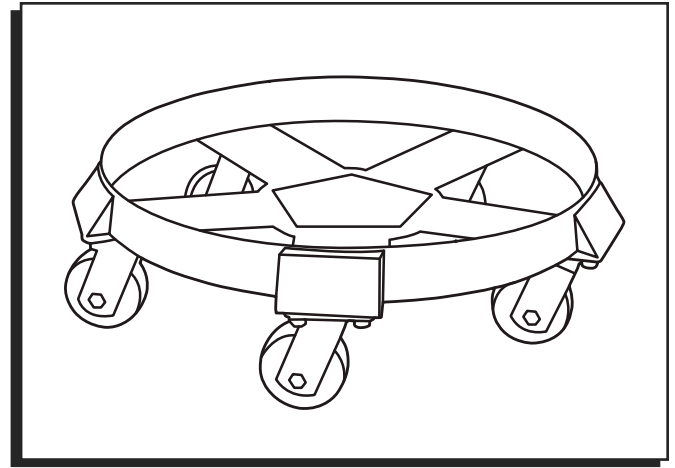

Figure 1

**ULINE H-5730**

**PLATAFORMA  
DE ACERO  
DE USO PESADO  
PARA TAMBOS**

800-295-5510  
uline.mx



**HERRAMIENTA NECESARIA**



Llave de 5/8"

**PARTES**



5 Ruedas



20 Rondanas de Seguridad

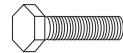

20 Pernos



20 Rondanas



20 Tuercas

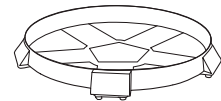

1 Armazón de Plataforma para Tambo

**ENSAMBLE**

**INSTALE LAS RUEDAS**

1. Voltee el armazón de la plataforma boca abajo.
2. Alinee la rueda con los orificios para pernos. Inserte el perno, rondana, rondana de seguridad y ajuste con la tuerca. (Vea Diagrama 1)
3. Apriete las tuercas con una llave de 5/8".
4. Repita la operación con las ruedas restantes.

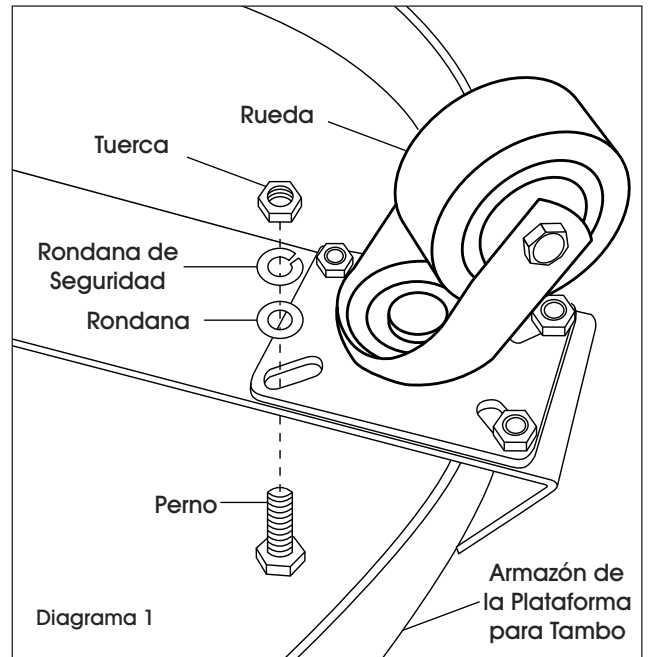

# ULINE H-5730

## SOCLE ROULANT POUR BARIL ROBUSTE EN ACIER

1-800-295-5510  
uline.ca

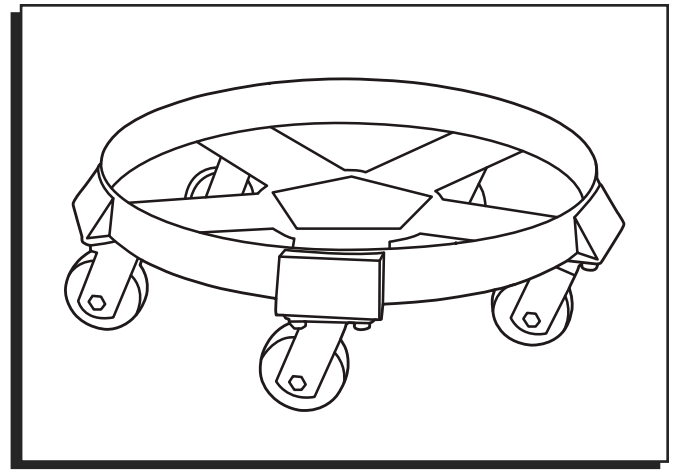

### OUTIL REQUIS



Clé de 5/8 po

## PIÈCES



Roulette x 5



Rondelle de blocage x 20

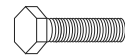

Boulon x 20



Rondelle x 20



Écrou x 20

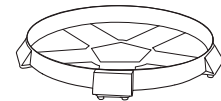

Cadre de socle roulant x 1

## MONTAGE

### INSTALLATION DES ROULETTES

1. Retournez le cadre de socle roulant à l'envers.
2. Alignez les roulettes avec les trous de boulons. Insérez le boulon, la rondelle, la rondelle de blocage et fixez avec l'écrou. (Voir figure 1)
3. Serrez les écrous avec une clé de 5/8 po.
4. Répétez les étapes pour le reste des roulettes.

