

ULINE H-5179

WELDING SCREEN – 6 x 8'

1-800-295-5510
uline.com

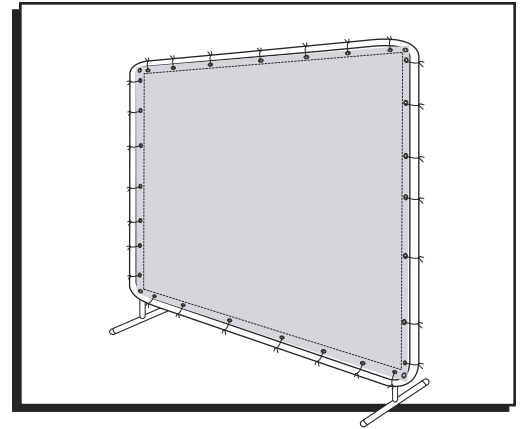

PARTS

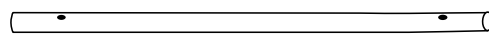

Long Non-Tapered Tube (A) x 2

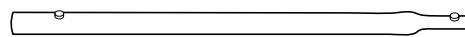

Long Tapered Tube (B) x 4

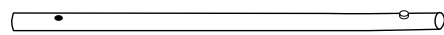

Medium Non-Tapered Tube (C) x 2

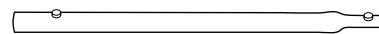

Short Tapered Tube (D) x 2

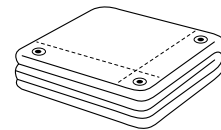

Curtain x 1



Curtain Tie x 36

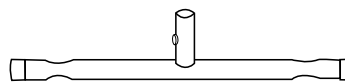

Foot (G) x 2

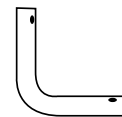

Corner (E) x 2

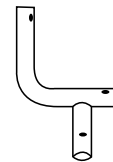

Corner with Foot Adapter (F) x 2

ASSEMBLY

1. Assemble the top and bottom frames by connecting the short tapered (D), long non-tapered (A) and long tapered (B) tubes until pins snap and lock in place.
2. Assemble the left and right frames by connecting the medium non-tapered (C) and long tapered (B) tubes until pins snap and lock in place.
3. Connect the corners (E) with the top, left and right frames until pins snap and lock in place.
4. Connect the corners with foot adapters (F) to the bottom, left and right frames until pins snap and lock in place.
5. Connect a foot (G) to each corner with foot adapter (F) until pins snap and lock in place.
6. With your frame assembled, begin attaching the curtain to the frame using the curtain ties.

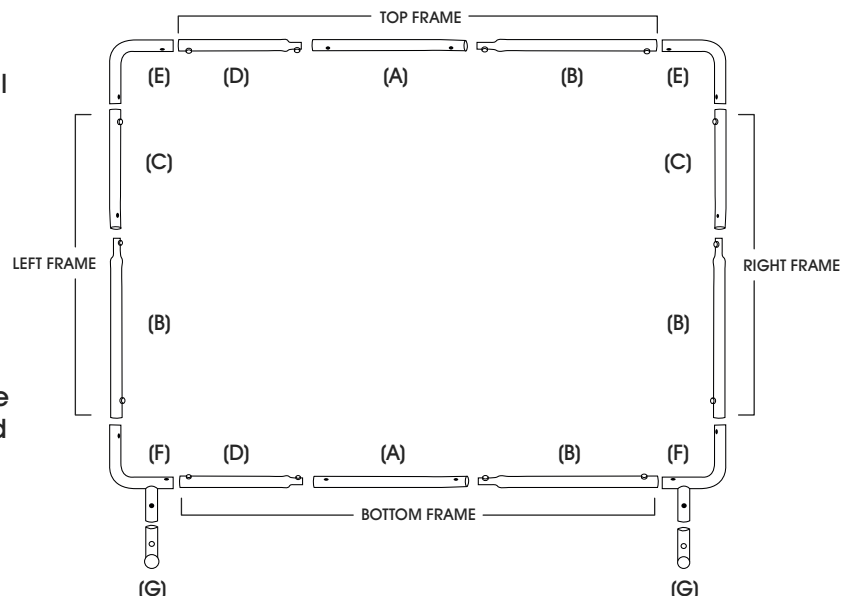

ULINE H-5179

CORTINA PARA SOLDAR – 6 x 8'

800-295-5510
uline.mx

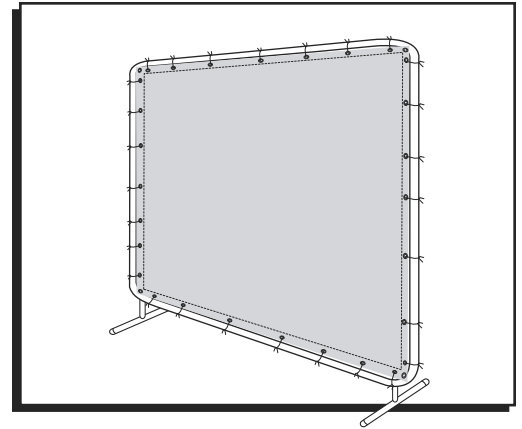

PARTES

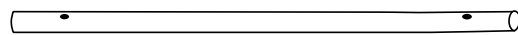

2 Tubos Largos No Cónicos (A)

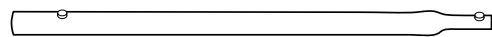

4 Tubos Largos Cónicos (B)

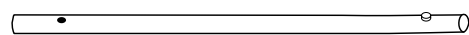

2 Tubos Medianos No Cónicos (C)

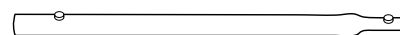

2 Tubos Cortos Cónicos (D)

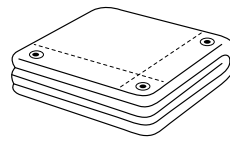

1 Cortina



36 Cinchos para Cortina

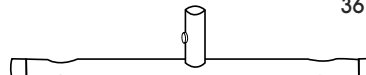

2 Patas (G)

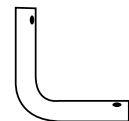

2 Esquinas (E)

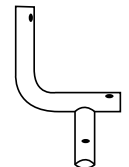

2 Esquinas con Adaptador para Patas (F)

ENSAMBLE

1. Ensamble los armazones superior e inferior conectando el tubo corto cónico (D), largo no cónico (A) y largo cónico (B), hasta que el pivote se ajuste y asegure en su lugar.
2. Ensamble los armazones izquierdo y derecho conectando el tubo mediano no cónico (C) y largo cónico (B), hasta que el pivote se ajuste y asegure en su lugar.
3. Conecte las esquinas (E) con los armazones superior, izquierdo y derecho hasta que el pivote se ajuste y asegure en su lugar.
4. Conecte las esquinas con adaptadores para pata (F) a los armazones inferior, izquierdo y derecho hasta que los pasadores encajen en su lugar.
5. Conecte la pata (G) a cada esquina con el adaptador para patas (F) hasta que el pivote se ajuste y asegure en su lugar.
6. Con el armazón ensamblado, empiece a colocar la cortina en el armazón utilizando los cinchos para cortina.

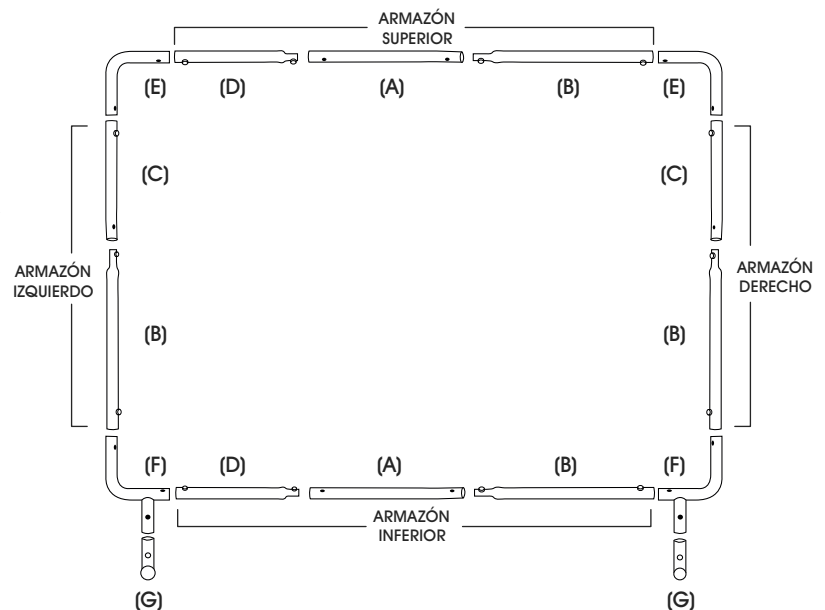

ULINE H-5179

ÉCRAN DE SÉCURITÉ POUR SOUDURE – 6 x 8 pi

1-800-295-5510
uline.ca

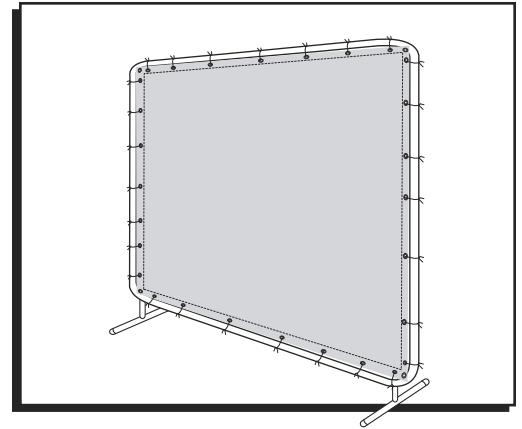

PIÈCES

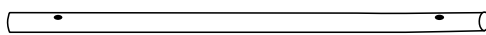

Long tube non conique (A) x 2

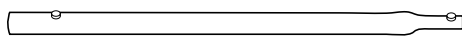

Long tube conique (B) x 4

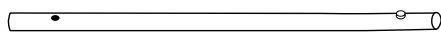

Tube moyen non conique (C) x 2

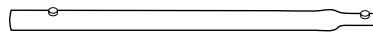

Petit tube conique (D) x 2

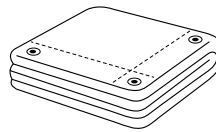

Rideau x 1



Attache de rideau x 36

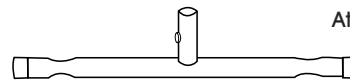

Tube de pied (G) x 2

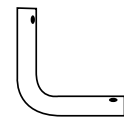

Tube de coin (E) x 2

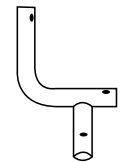

Tube de coin avec adaptateur de pied (F) x 2

MONTAGE

1. Assemblez les côtés supérieur et inférieur en rattachant le petit tube conique (D), le long tube non conique (A) et le long tube conique (B) jusqu'à ce que les goupilles se verrouillent en place.
2. Assemblez les côtés latéraux gauche et droit en rattachant le tube moyen non conique (C) avec le long tube conique (B) jusqu'à ce que les goupilles se verrouillent en place.
3. Reliez les tubes de coin (E) avec les côtés supérieur, gauche et droit jusqu'à ce que les goupilles se verrouillent en place.
4. Connectez les tubes de coin avec adaptateur de pied (F) aux côtés inférieur, gauche et droit jusqu'à ce que les goupilles se verrouillent en place.
5. Connectez un tube de pied (G) à chaque tube de coin avec adaptateur de pied (F) jusqu'à ce que les goupilles se verrouillent en place.
6. Avec le montage du cadre maintenant terminé, commencez à installer le rideau au cadre en utilisant les attaches de rideau.

