

# ULINE H-5121 MARINE SHRINK CART

1-800-295-5510  
uline.com

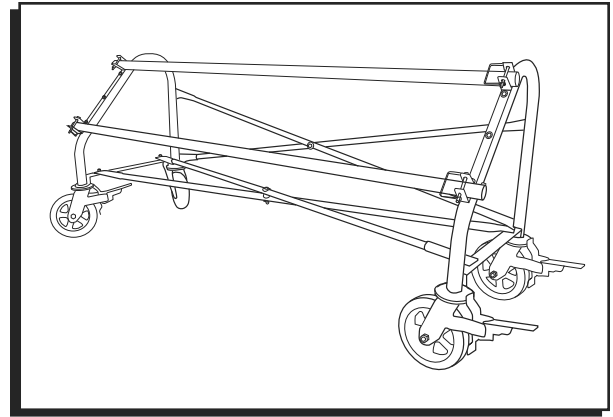

## TOOLS NEEDED



3/8" Combination Wrench  
or Socket Wrench

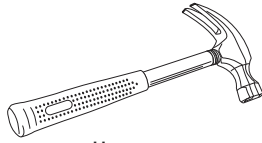

Hammer

## PARTS



A

3/8" Nuts x 8



B

Support Pole D-clip x 4

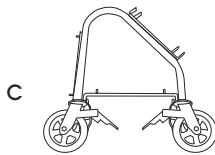

C

Caster/Frame x 2

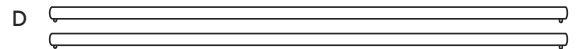

D

Support Poles x 2

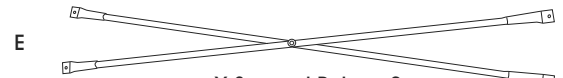

E

X-Support Poles x 2

## ASSEMBLY

1. Attach X-Support Pole (E) to the bottom of Caster/Frame (C) using 3/8" nuts (A). Tighten nuts firmly, but not completely, in order to retain flexibility. Repeat process for the other Caster/Frame (C).



**Note:** If the holes at the end of each X-Support Pole (E) do not line up, lightly tap the ends with a hammer until holes line up. (See Figure 1)

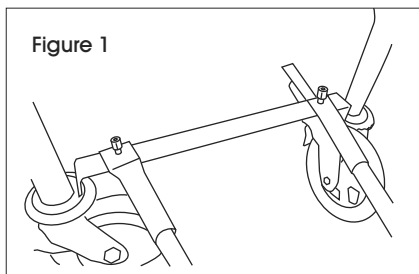

Figure 1

2. Attach X-Support Pole (E) to the backside of the Caster/Frame (C) using 3/8" nuts (A). Tighten nuts firmly, but not completely, in order to retain flexibility. Repeat process for the other Caster/Frame (C). (See Figure 2)

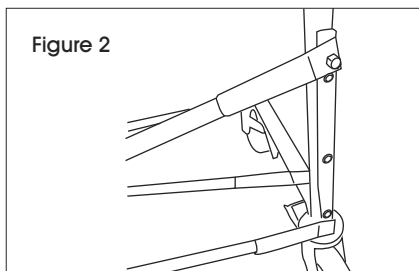

Figure 2

3. Place Support Poles (D) in U-shape holders on front side of Caster/Frame (C). Keep Support Poles in place by inserting Support Pole D-clips (B) in the holes on the U-shape holder. To insert Support Pole D-clips (B), first open the D-clip by pulling down on the spring, put through the two holes, and then release the spring. Repeat process for both Support Poles (D). (See Figure 3)

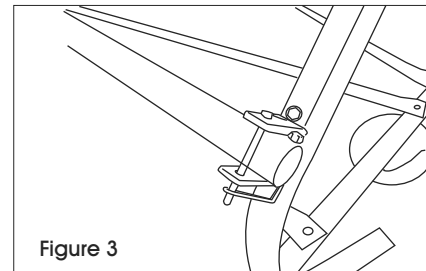

Figure 3

4. Double check all nuts and bolts used in assembly. Tighten each securely.

# ULINE H-5121

## CARRITO PARA TERMOENCOGIBLE MARINA

800-295-5510  
uline.mx

### HERRAMIENTAS NECESARIAS



Llave Combinada o de Dado de 3/8"

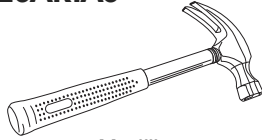

Martillo

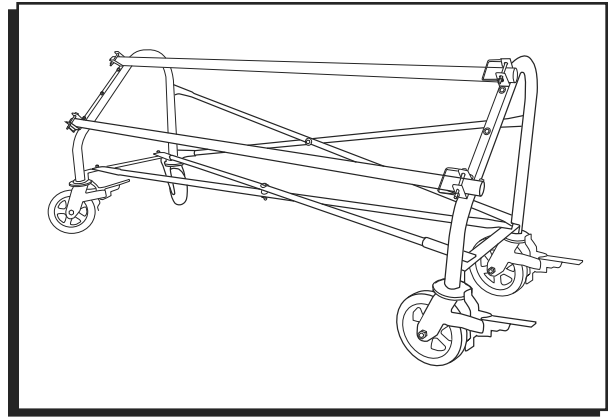

### PARTES



8 Tuercas de 3/8"



4 Clips en D para Postes de Soporte

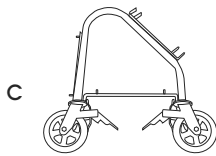

2 Ruedas/Armazón

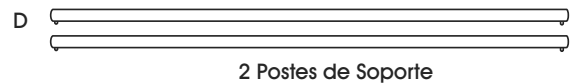

2 Postes de Soporte



2 Postes de Soporte en X

### ENSAMBLE

1. Fije el Poste de Soporte en X (E) a la parte inferior de las Ruedas/Armazón (C) usando tuercas de 3/8" (A). Apriete las tuercas firmemente, pero no del todo, para conservar la flexibilidad. Repita el proceso para la otra Rueda/Armazón (C).



**Nota:** Si los orificios ubicados en los extremos de cada uno de los Postes de Soporte en X (E) no se alinean, golpee ligeramente los extremos con un martillo hasta que los orificios se alineen. (Vea Diagrama 1)

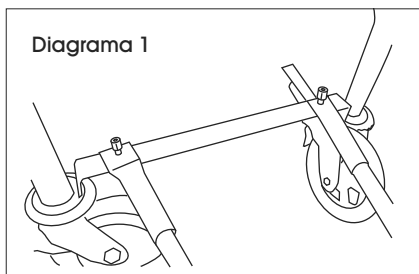

2. Fije el Poste de Soporte en X (E) a la parte posterior de las Ruedas/Armazón (C) usando tuercas de 3/8" (A). Apriete las tuercas firmemente, pero no del todo, para conservar la flexibilidad. Repita el proceso para la otra Rueda/Armazón (C). (Vea Diagrama 2)

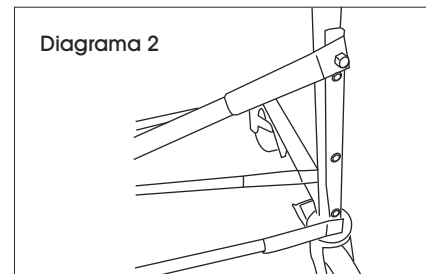

3. Coloque los Postes de Soporte (D) en los soportes en forma de U ubicados en la parte delantera de la Rueda/Armazón (C). Mantenga los Postes de Soporte en su lugar insertando clips en D para Postes de Soporte (B) en los orificios del soporte en forma de U. Para insertar los clips en D para Postes de Soporte (B), abra primero el clip en D empujando el resorte hacia abajo, insértelo a través de los dos orificios y luego libere el resorte. Repita el proceso para ambos Postes de Soporte (D). (Vea Diagrama 3)

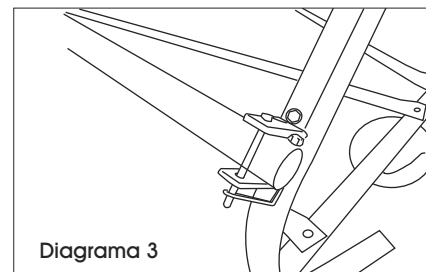

4. Verifique todas las tuercas y pernos usados en el ensamble. Apriete bien cada uno de ellos.

# ULINE H-5121

## CHARIOT À FILM RÉTRACTABLE MARINE

1-800-295-5510  
uline.ca

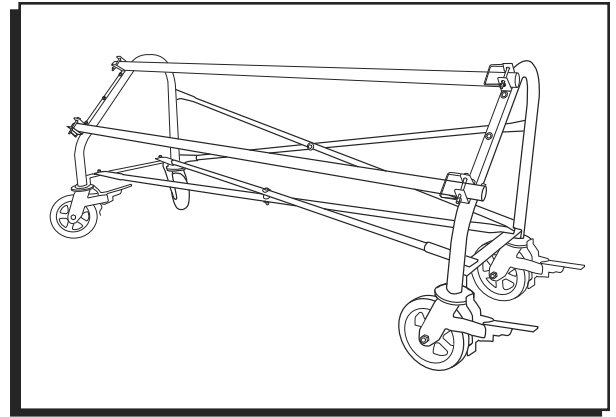

### OUTILS REQUIS



Clé mixte ou à douilles de 3/8 po

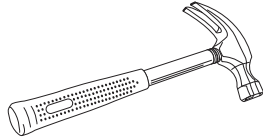

Marteau

### PIÈCES



A Écrous de 3/8 po x 8



B Goupille de fixation pour barre de soutien x 4

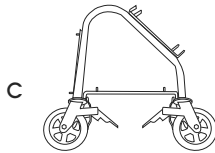

C Cadre avec roulettes x 2

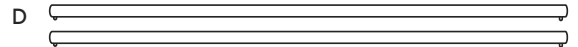

D Barres de soutien x 2

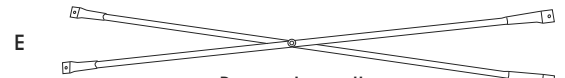

E Barres de soutien croisées x 2

### ASSEMBLAGE

- Fixez la barre de soutien croisée (E) à la base du cadre avec roulettes (C) à l'aide d'écrous de 3/8 po (A). Serrez fermement les écrous, mais pas complètement, afin de conserver une certaine marge de manœuvre. Répétez l'opération pour l'autre cadre avec roulettes (C).

 **REMARQUE :** Si les trous à l'extrémité de chaque barre de soutien croisée (E) ne sont pas alignés, tapotez les extrémités à l'aide d'un marteau jusqu'à ce que les trous soient alignés. (Voir Figure 1)

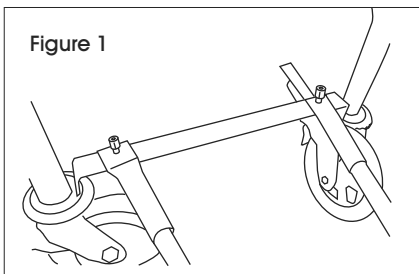

- Fixez la barre de soutien croisée (E) à l'arrière du cadre avec roulettes (C) à l'aide d'écrous de 3/8 po (A). Serrez fermement les écrous, mais pas complètement, afin de conserver une certaine marge de manœuvre. Répétez l'opération pour l'autre cadre avec roulettes (C). (Voir Figure 2)

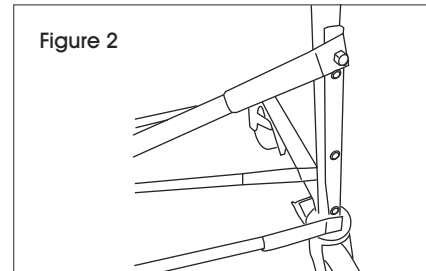

- Placez les barres de soutien (D) dans les supports en forme de U à l'avant du cadre avec roulettes (C). Maintenez les barres de soutien en place en insérant les goupilles de fixation pour barre de soutien (B) dans les trous des supports en U. Pour insérer les goupilles de fixation pour barre de soutien (B), ouvrez d'abord la goupille en abaissant le ressort, insérez-la dans les deux trous, puis relâchez le ressort. Répétez l'opération pour les deux barres de soutien (D). (Voir Figure 3)

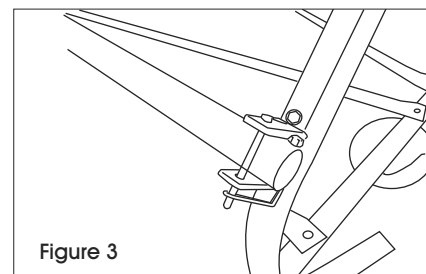

- Vérifiez tous les écrous et boulons utilisés pour l'assemblage. Serrez-les tous fermement.