

ULINE H-3746

ALUMINUM BACKLESS BENCH

1-800-295-5510
uline.com

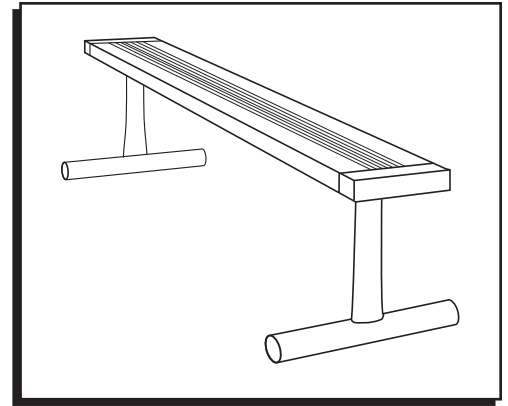

TOOLS NEEDED



Power Drill

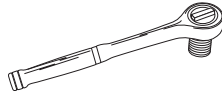

Socket Wrench



Rubber Mallet



Two Person Assembly
Recommended

PARTS

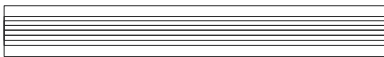

Aluminum Seat Plank x 1

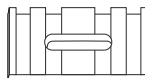

Hold Down Clip x 8



5/16" x 1 1/2"
Carriage Bolt x 8



Plastic
Round Cap x 4



End Cap for Plank x 2



3/16" Self-Tapping Screw x 4



5/16" Flange Nut x 8

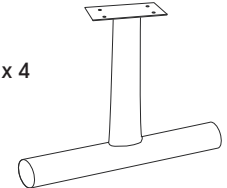

Galvanized Leg Frame x 2

ASSEMBLY INSTRUCTIONS

1. Lay the seat plank upside down on a flat surface. Slide the end caps onto each end of the plank. The pre-drilled holes of the end cap should be facing up. Use power drill and two self-tapping screws to secure each end cap onto each end of the plank. (See Figure 1)
2. Place one leg frame at a time 6" from the end of the seat plank. (See Figure 2)
3. Loosely attach using four hold down clips, four 5/16" flange nuts and four 5/16" carriage bolts per leg frame.
4. Push the two plastic round caps into each leg frame using a rubber mallet.
5. Flip the bench right side up. Make sure legs are evenly aligned to the edges and the bench is level. Tighten the bolts using a socket wrench. (See Figure 3)

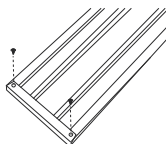

Figure 1



NOTE: H-3748 mounting hardware sold separately.



NOTE: If the material is to be stored in a location where moisture is a possibility, the planks should be unbundled and stacked so that surfaces are not touching. This will prevent galvanic reaction from occurring or stains from paper or cardboard packaging should the planks get wet. Once the bench has been assembled, the problem no longer exists.

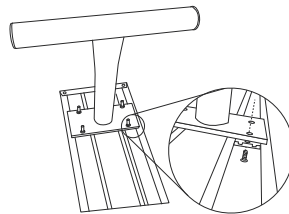

Figure 2

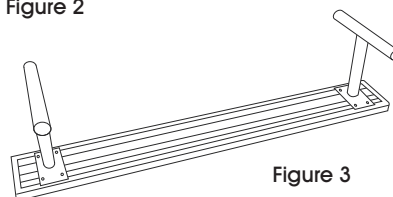

Figure 3

ULINE H-3746

BANCA DE ALUMINIO SIN RESPALDO

800-295-5510

uline.mx

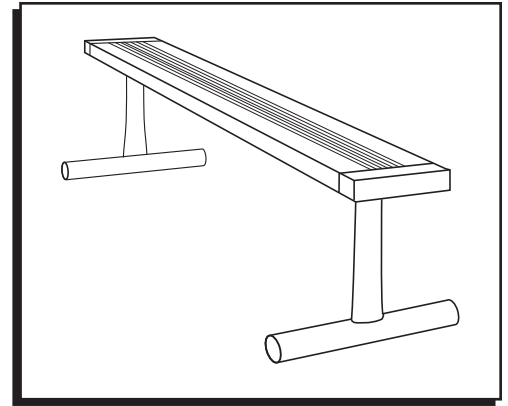

HERRAMIENTAS NECESARIAS



Taladro Eléctrico

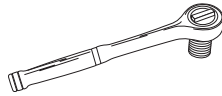

Llave de Dado



Mazo de Hule



Se recomienda Armar
Entre Dos Personas

PARTES

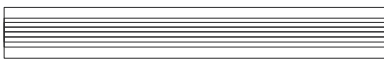

1 Tabla de Asiento de Aluminio

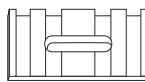

8 Clip de Sujeción



8 Perno de Cabeza Redonda de 5/16" x 1 1/2"



4 Tapa de Plástico Redonda

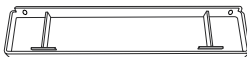

2 Tapa para Extremo de la Tabla



4 Tornillo Autoperforante de 3/16"



8 Tuerca de 5/16" con Reborde

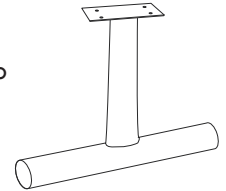

2 Armazon de Pata Galvanizado

INSTRUCCIONES DE ENSAMBLE

1. Coloque la tabla de asiento boca abajo sobre una superficie plana. Deslice las tapas de metal para extremos para colocarlas en cada uno de los extremos de las tablas. Los orificios pretaladrados de la tapa de extremo deberían apuntar hacia arriba. Use el taladro eléctrico y dos tornillos autoperforantes para fijar cada una de las tapas para extremos a cada uno de los extremos de la tabla. (Vea Diagrama 1)



Diagrama 1

2. Coloque un armazón de pata a la vez a 15.2 cm (6") del extremo de la tabla de asiento. (Vea Diagrama 2)

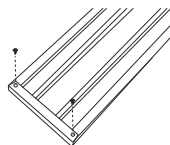

Diagrama 2

3. Fijelos sin apretar usando cuatro clips de sujeción, cuatro tuercas de 5/16" con reborde y cuatro pernos de cabeza redonda de 5/16" por armazón de pata.

4. Inserte las dos tapas de plástico redondas en a la uno de los armazones de pata usando un mazo de hule. Voltee la banca a su posición normal.

5. Asegúrese que las patas están correctamente alineadas y que los extremos de la banca estén nivelados. Apriete los pernos usando una llave de dado. (Vea Diagrama 3)

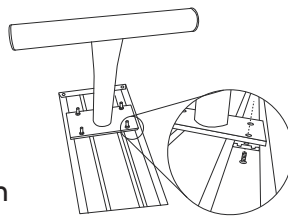

Diagrama 3



NOTA: La tornillería de instalación para H-3748 se vende por separado.

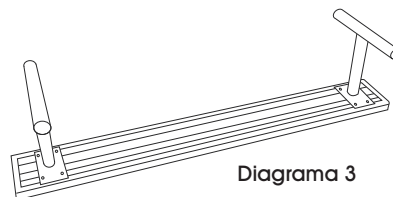

NOTA: Si el material debe almacenarse en un lugar donde podría haber humedad, las tablas deberán agruparse y estibarse de forma que las superficies no se toquen. Esto evitará que se produzca una reacción galvánica o que aparezcan manchas de los empaques de papel o cartón en caso de que las tablas se humedezcan. Una vez que la banca se haya ensamblado, este problema ya no ocurrirá.

ULINE H-3746

BANC EN ALUMINIUM SANS DOSSIER

1-800-295-5510
uline.ca

OUTILS REQUIS



Perceuse électrique

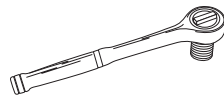

Clé à douilles



Maillet en caoutchouc

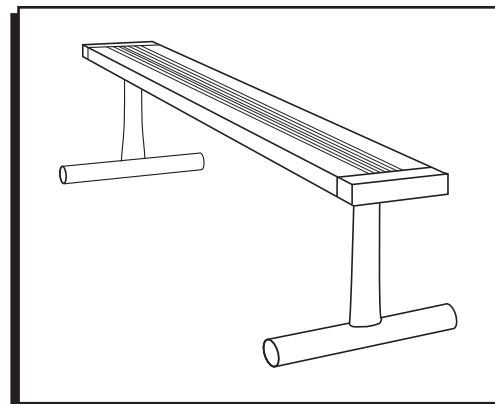

Montage à deux
personnes recommandé

PIÈCES



Planche de banc en
aluminium x 1



Attache de maintien x 8

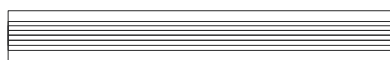
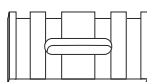

Boulon de carrosserie de
5/16 po x 1 1/2 po



Embout rond
en plastique x 4



Embout en métal pour
planche x 2



Vis autotaraudeuse de
3/16 po x 4



Écrou à embase de
5/16 po x 8

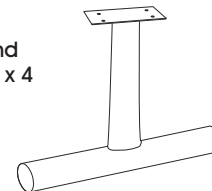

Cadre de patte
galvanisés x 2

INSTRUCTIONS D'ASSEMBLAGE

1. Placez le banc à l'envers sur une surface plane. Installez les embouts en métal à chaque extrémité de la planche. Les trous préperçés des embouts doivent être orientés vers le haut. Utilisez la perceuse électrique et deux vis autotaraudeuses pour fixer chaque embout à chaque extrémité de la planche. (Voir Figure 1)

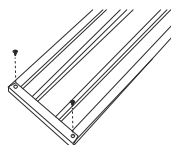

Figure 1

2. Placez un cadre de patte à la fois à une distance de 15,2 cm (6 po) à partir de l'extrémité de la planche de banc. (Voir Figure 2)

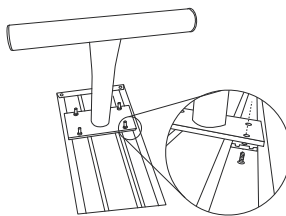

Figure 2

3. Fixez lâchement à l'aide de quatre attaches de maintien, quatre écrous à embase de 5/16 po et quatre boulons de carrosserie de 5/16 po par cadre de patte.

4. Poussez les deux embouts ronds en plastique dans chaque cadre de patte à l'aide d'un maillet en caoutchouc. Retournez le banc sur ses pattes.

5. Assurez-vous que les pattes sont parfaitement alignées aux bords et que le banc est de niveau. Serrez les boulons à l'aide d'une clé à douilles. (Voir Figure 3)

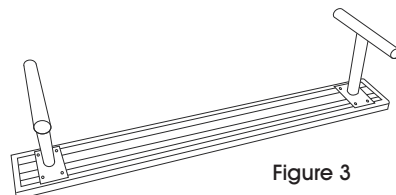

Figure 3



REMARQUE : Matériel d'installation H-3748 vendu séparément.



REMARQUE : Si le matériel doit être rangé dans un endroit où il y a un risque d'humidité, les planches doivent être démontées et empilées de telle manière que les surfaces ne se touchent pas. Cela permettra d'éviter une réaction galvanique ou des taches causées par le papier ou le carton d'emballage si les planches se mouillent. Une fois le banc assemblé, le problème ne se pose plus.