

**ULINE** H-3575, H-3576  
H-3577, H-3578  
**PLASTIC DUNNAGE RACKS**

1-800-295-5510  
uline.com

**ASSEMBLY INSTRUCTIONS**

**Step 1** – Lay panel face down and insert 12" posts as shown.  
(Make sure posts are pushed all the way down.)

**Step 2** – Return rack to upright position.

 **Note: Oil all sockets before assembly.**

**COMPONENTS**  
**H-3575**



Panel: (1) 36 x 24"  
Posts: (5) 12"

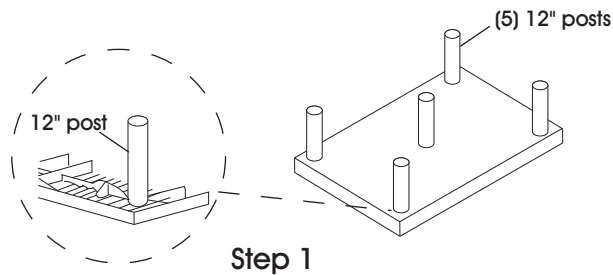

**Step 1**

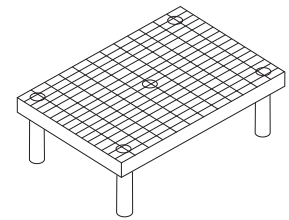

**Step 2**

**COMPONENTS**  
**H-3576**

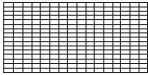

Panel: (1) 48 x 24"  
Posts: (9) 12"

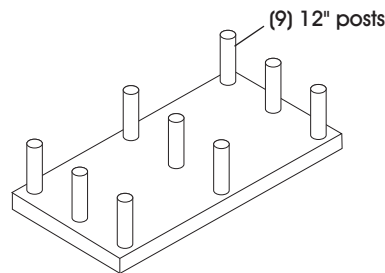

**Step 1**

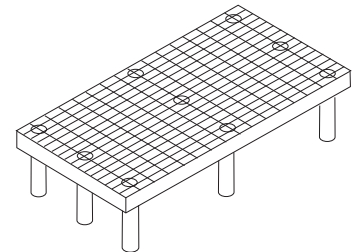

**Step 2**

**COMPONENTS**  
**H-3577**

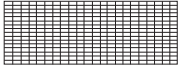

Panel: (1) 66 x 24"  
Posts: (8) 12"

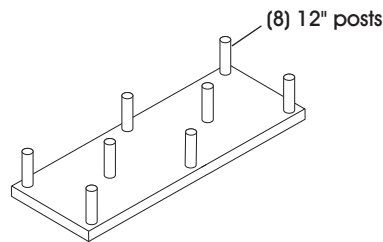

**Step 1**

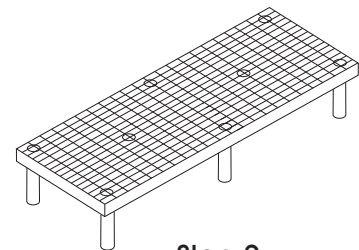

**Step 2**

**COMPONENTS**  
**H-3578**

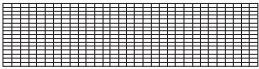

Panel: (1) 96 x 24"  
Posts: (11) 12"

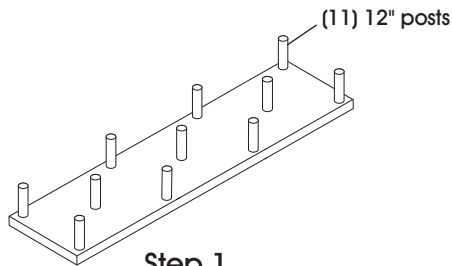

**Step 1**

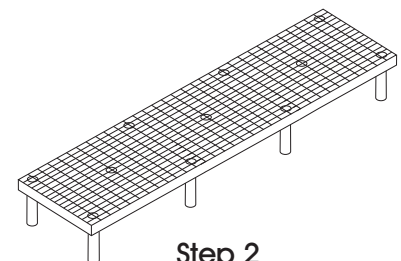

**Step 2**



H-3575, H-3576  
H-3577, H-3578

# RACKS DE PLÁSTICO PARA CARGA

800-295-5510  
uline.mx

## INSTRUCCIONES DE ENSAMBLE

**Paso 1** – Coloque el panel boca abajo e inserte los postes de 30.5 cm (12") como se muestra. (Asegúrese de que los postes están insertados hasta el fondo).

**Paso 2** – Vuelva a colocar el rack en posición vertical.

 **Nota:** Lubrique todas las ranuras antes del ensamble.

**COMPONENTES:  
H-3575**



Panneau : (1) 91.4 x 61 cm  
(36 x 24")  
Montants : (5) 30.5 cm (12")

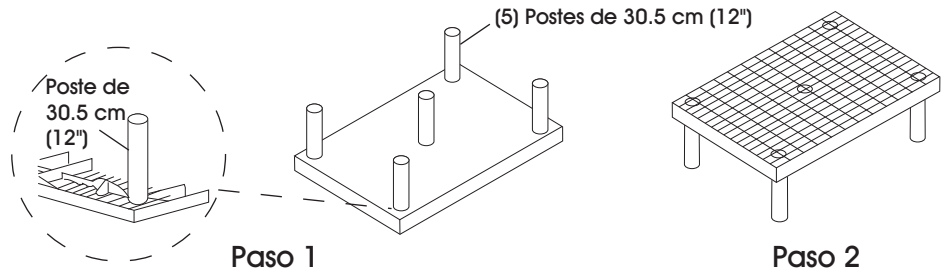

**COMPONENTES:  
H-3576**

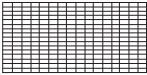

Panneau : (1) 122 x 61 cm  
(48 x 24")  
Montants : (9) 30.5 cm (12")

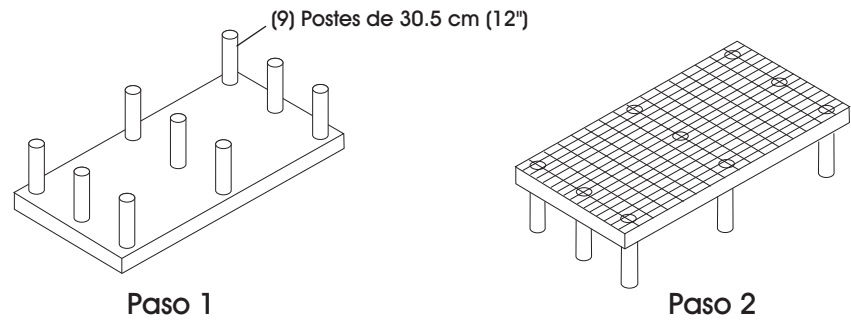

**COMPONENTES:  
H-3577**

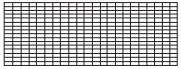

Panneau : (1) 167.6 x 61 cm  
(66 x 24")  
Montants : (8) 30.5 cm (12")

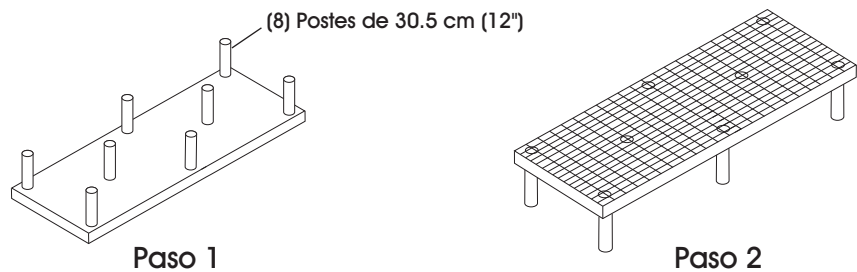

**COMPONENTES:  
H-3578**

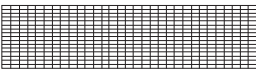

Panneau : (1) 243.8 x 61 cm  
(96 x 24")  
Montants : (11) 30.5 cm (12")

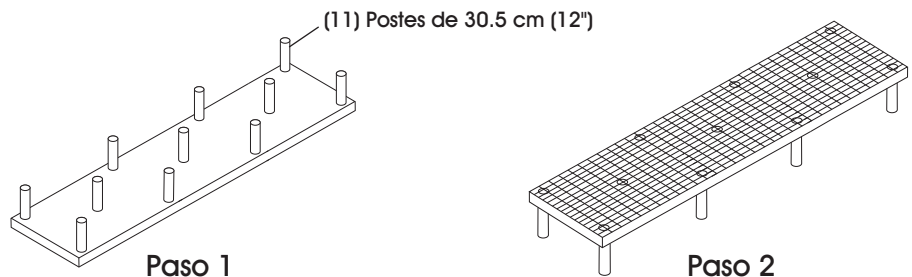

**SUPPORTS DE FARDAGE  
EN PLASTIQUE****INSTRUCTIONS D'ASSEMBLAGE**

Étape 1 – Déposez le panneau face contre terre et insérez les montants de 30,5 cm (12 po) comme indiqué. (Assurez-vous que les montants sont complètement enfoncés.)

Étape 2 – Retournez le support en position debout.



**REMARQUE :** Huilez toutes les emboîtures avant l'assemblage.

