

# ULINE H-3403, H-3809 LOCKOUT/TAGOUT WALL MOUNT STATION

1-800-295-5510  
uline.com

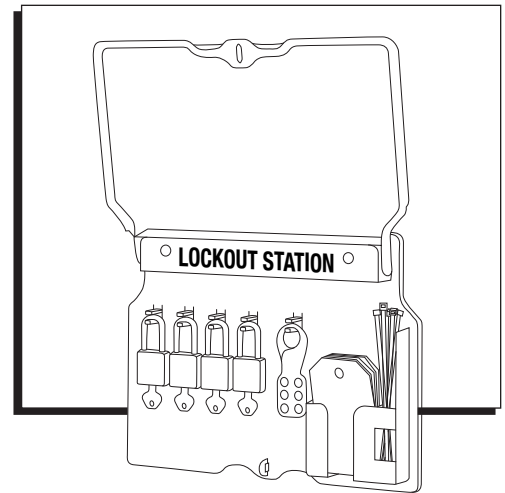

## ASSEMBLY

### TO REMOVE COVER

 **NOTE:** Do not attempt to remove cover in closed position.

1. Rotate cover to open position. (See Figure 1)
2. Gently pry one hinge tab out until it releases from base. (See Figure 2)
3. Repeat on opposite side with second hinge tab.
4. Remove cover.

### TO INSTALL COVER

1. Place cover in open position. (See Figure 1)
2. Insert hinge tabs. (See Figure 3)
3. Lower cover.

Figure 1

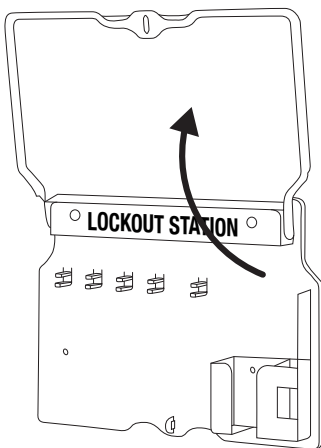

Figure 2

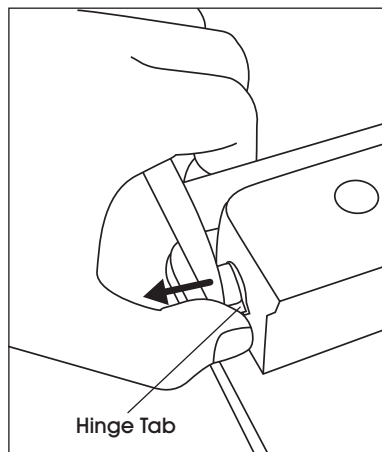
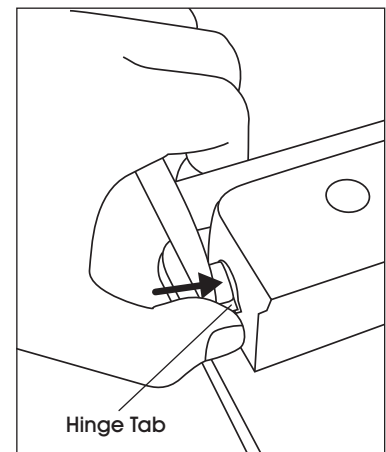

Figure 3



## INSTALLATION

Mount station to wall using four (4) #6 screws (not included). Be sure screws are long enough to ensure station is securely mounted to wall. (See Figure 4)

Figure 4

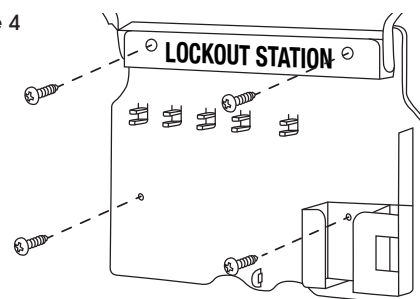

# ULINE H-3403, H-3809 ESTACIÓN DE BLOQUEO/ ETIQUETADO DE PARED

800-295-5510  
uline.mx

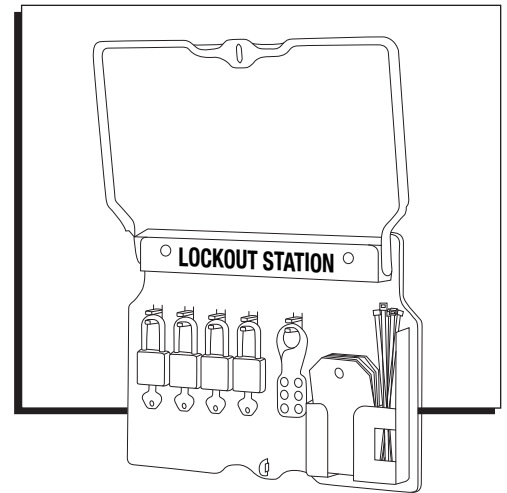

## ENSAMBLE

### PARA QUITAR LA CUBIERTA

 **NOTA:** No intente quitar la cubierta en la posición cerrada.

1. Gire la cubierta hasta la posición de abierto. (Vea Diagrama 1)
2. Con cuidado saque una de las lengüetas de la bisagra hasta que se desprenda de la base. (Vea Diagrama 2)
3. Repita la operación en el lado opuesto con la segunda lengüeta de la bisagra.
4. Quite la cubierta.

Diagrama 1

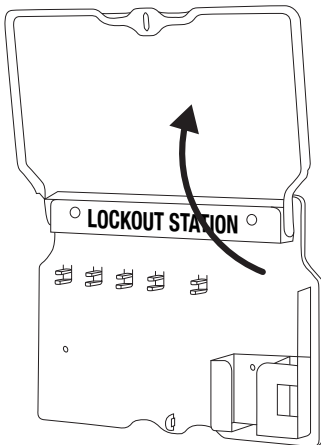

### PARA INSTALAR LAS CUBIERTA

1. Coloque la cubierta en la posición de abierto. (Vea Diagrama 1)
2. Inserte las lengüetas de la bisagra. (Vea Diagrama 3)
3. Baje la cubierta.

Diagrama 2



Diagrama 3



## INSTALACIÓN

Fije la estación a la pared usando cuatro (4) tornillos #6 (no incluidos). Asegúrese de que los tornillos son lo suficientemente largos como para que la estación quede bien montada sobre la pared. (Vea Diagrama 4)

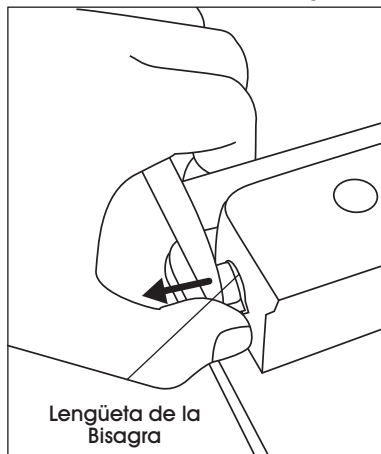
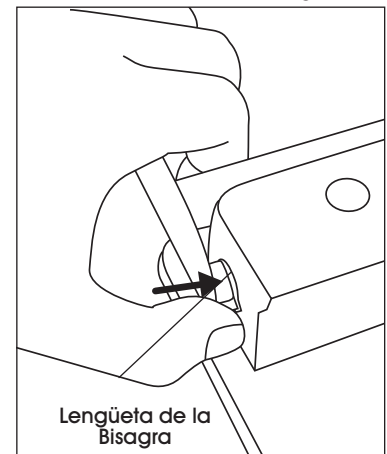
Diagrama 4

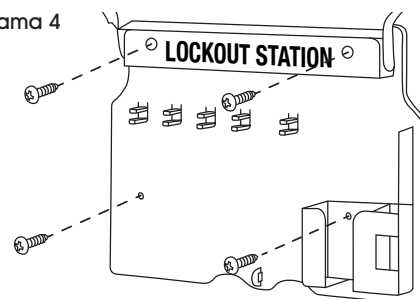

**ULINE** H-3403, H-3809

# STATION MURALE DE VERROUILLAGE ET D'ÉTIQUETAGE

1-800-295-5510  
uline.ca

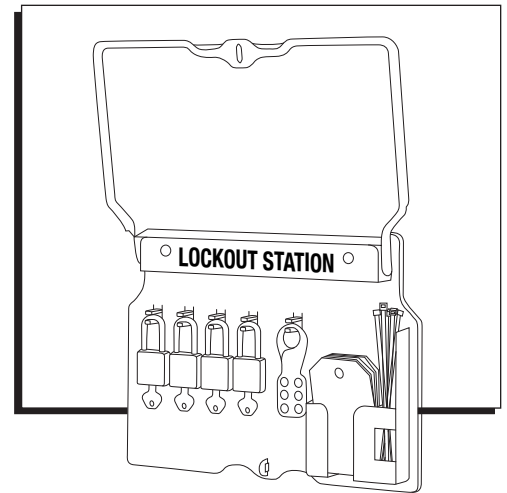

## MONTAGE

### POUR RETIRER LE COUVERCLE

 **REMARQUE :** Ne tentez pas de retirer le couvercle en position fermée.

1. Placez le couvercle en position ouverte. (Voir Figure 1)
2. Soulevez délicatement une patte de charnière jusqu'à ce qu'elle se libère de la base. (Voir Figure 2)
3. Répétez du côté opposé avec l'autre patte de charnière.
4. Retirez le couvercle.

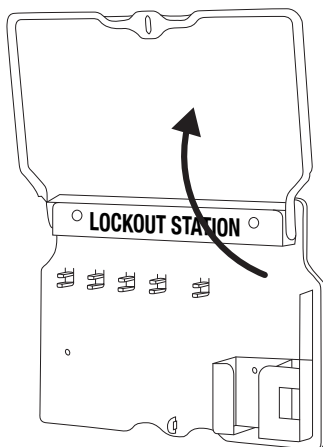

Figure 1

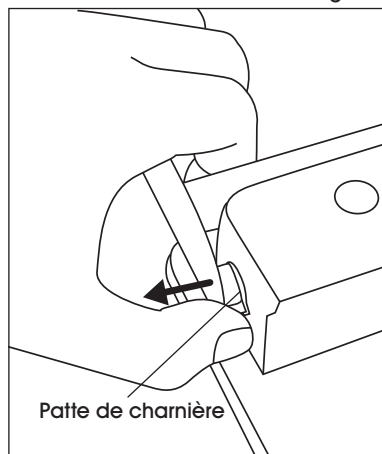

Figure 2

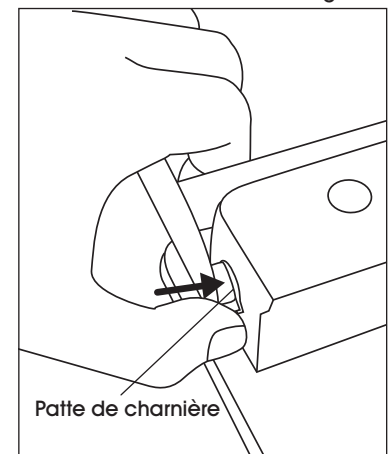

Figure 3

### POUR INSTALLER LE COUVERCLE

1. Placez le couvercle en position ouverte. (Voir Figure 1)
2. Insérez les pattes de charnière. (Voir Figure 3)
3. Abaissez le couvercle.

## INSTALLATION

Fixez la station au mur à l'aide de quatre (4) vis n° 6 (non comprises). Assurez-vous que les vis sont suffisamment longues pour que la station soit solidement fixée au mur. (Voir Figure 4)

Figure 4

