

ULINE H-1592 CHROME TOILET SEAT COVER DISPENSER

1-800-295-5510
uline.com

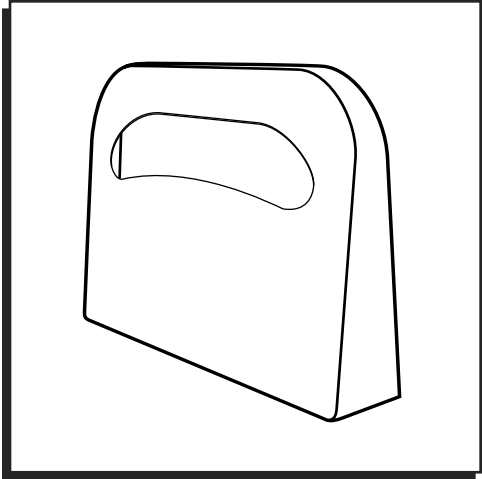

TOOLS NEEDED



Drill



Drill Bit

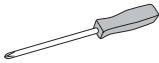

Phillips Head
Screwdriver



Level

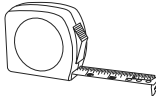

Tape Measure

PARTS

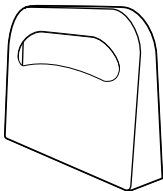

Dispenser x 1



Wall Anchor x 2

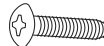

Screw x 2

MOUNTING INSTRUCTIONS



NOTE: Ensure that proper mounting hardware is used for appropriate wall composition. Enclosed hardware may not be compatible with wall surface.

- 1. Hold dispenser up to desired location and mark two holes on the wall where screws will be inserted. (See Figure 1)



- 2. Drill into wall at two marked locations with appropriate-sized drill bit. Insert wall anchors if necessary. (See Figure 2)

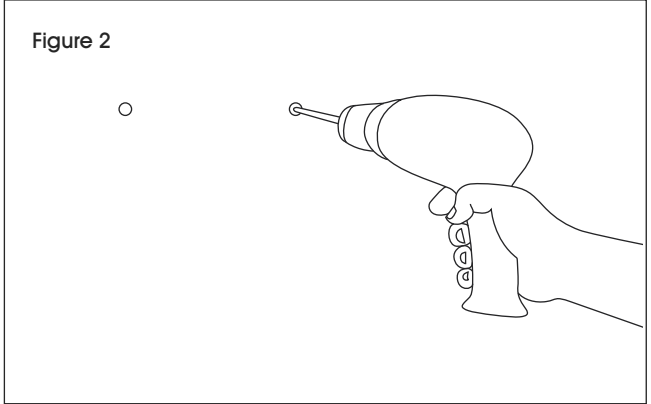

- 3. Hold dispenser over previously drilled holes and insert screws.

LOADING INSTRUCTIONS

1. Remove perforated tab from toilet seat cover pack.
2. Insert pack from the bottom of the dispenser. Push the bottom of the pack towards the back of the dispenser to keep it in place. (See Figure 3)

Figure 3

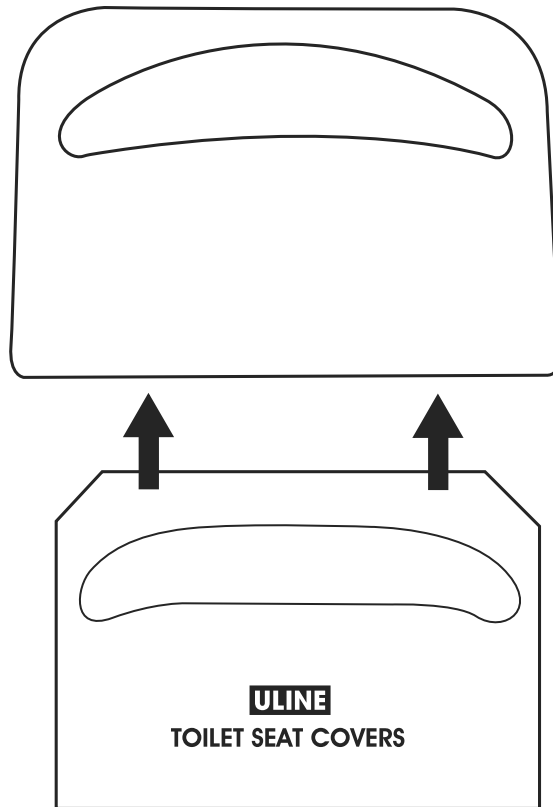

ULINE

1-800-295-5510
uline.com

ULINE H-1592 DESPACHADOR DE CUBREASIENTOS PARA BAÑO

800-295-5510
uline.mx

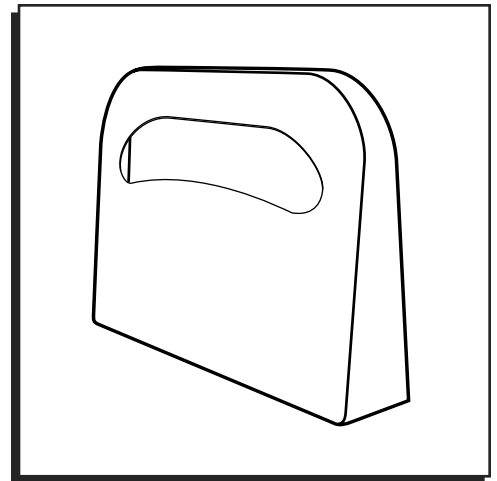

HERRAMIENTAS NECESARIAS



Taladro



Broca

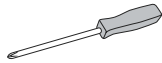

Desarmador
de Cruz



Nivelador

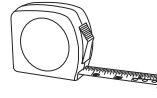

Cinta de
Medir

PARTES

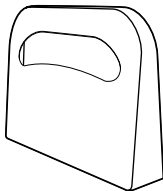

1 Despachador



2 Taquetes

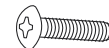

2 Tornillos

INSTRUCCIONES DE INSTALACIÓN



NOTA: Asegúrese de que se utilice la tornillería de instalación adecuada para la composición de pared apropiada. Es posible que la tornillería incluida no sea compatible con la superficie de la pared.

1. Sostenga el despachador en la ubicación deseada y marque dos orificios en la pared donde se colocarán los tornillos. (Vea Diagrama 1)

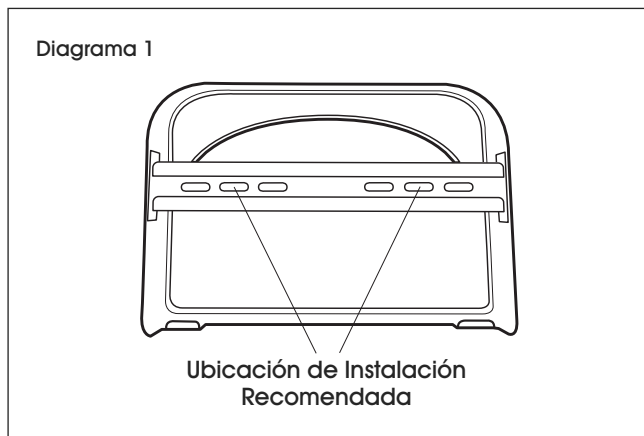

2. Perfore en la pared las cuatro ubicaciones marcadas con la broca del tamaño adecuado. Inserte los taquetes si es necesario. (Vea Diagrama 2)

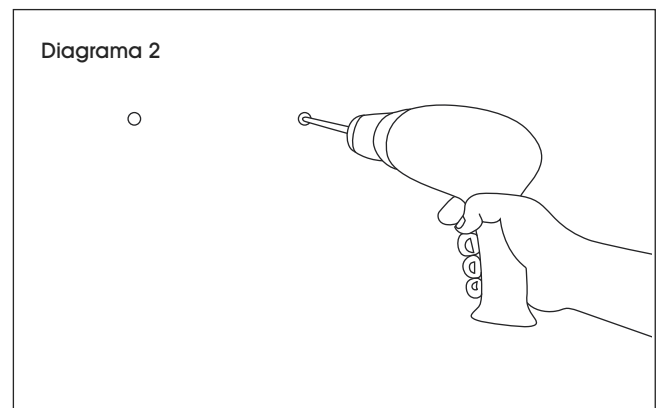

3. Sostenga el despachador sobre los orificios previamente perforados e inserte los tornillos.

INSTRUCCIONES DE CARGA

1. Retire la pestaña perforada del paquete del despachador de cubreasientos para baño.
2. Inserte el paquete de la parte inferior del despachador. Empuje la parte inferior del paquete hacia la parte posterior del despachador para mantenerlo en su lugar. (Vea Diagrama 3)

Diagrama 3

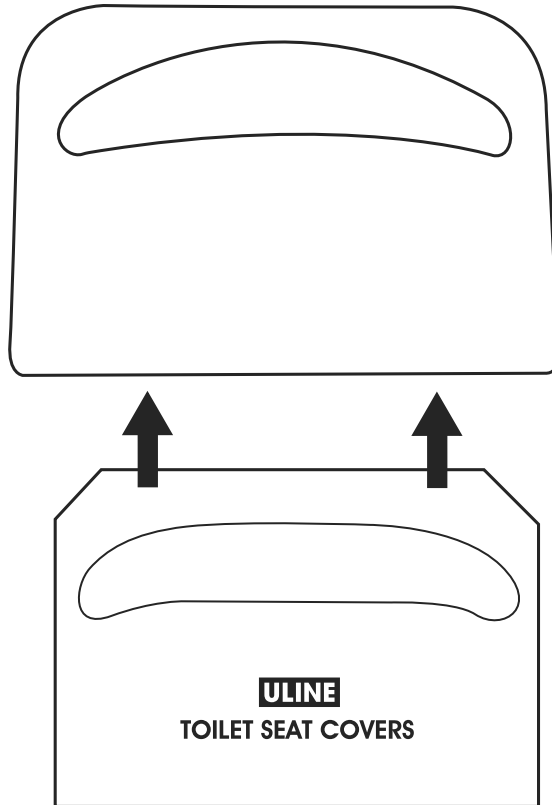

ULINE H-1592

1-800-295-5510

uline.ca

DISTRIBUTEUR DE COUVRE-SIÈGES DE TOILETTE – CHROMÉ

OUTILS REQUIS



Perceuse



Mèche de
perceuse

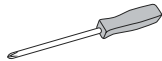

Tournevis
cruciforme

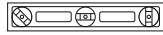

Niveau à
bulles

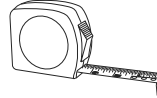

Ruban à
mesurer

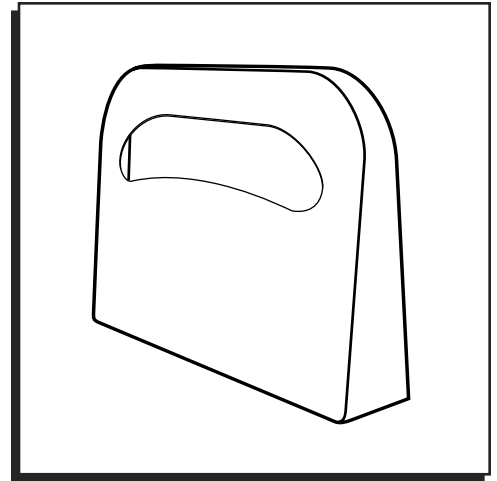

PIÈCES

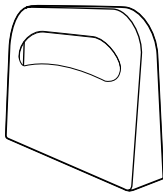

Distributeur x 1



Ancrage mural x 2

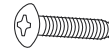

Vis x 2

INSTRUCTIONS DE MONTAGE



REMARQUE : Assurez-vous que le matériel d'installation utilisé est adapté à la composition du mur. Le matériel d'installation fourni peut ne pas être adapté à la surface du mur.

1. Tenez le distributeur à l'emplacement désiré et marquez deux trous sur le mur où les vis seront insérées. (Voir Figure 1)

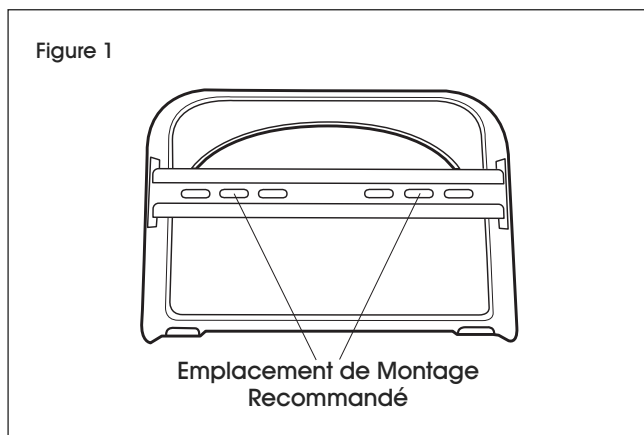

2. Percez le mur aux quatre endroits marqués à l'aide d'une mèche de perceuse de taille appropriée. Insérez les ancrages muraux si nécessaire. (Voir Figure 2)

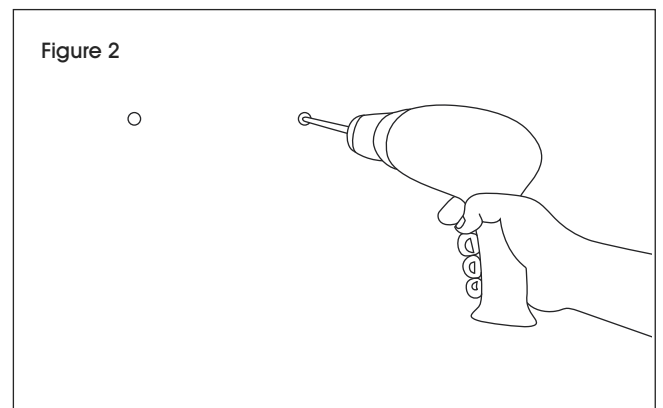

3. Maintenez le distributeur au niveau des trous percés et insérez les vis.

INSTRUCTIONS DE CHARGEMENT

1. Retirez la languette perforée du paquet de couvre-sièges de toilette.
2. Insérez le paquet par le bas du distributeur. Poussez le bas du paquet vers l'arrière du distributeur pour le maintenir en place. (Voir Figure 3)

Figure 3

