

Section 1

Re: Supply-043

Report Number: HM 11839
Date of Report: November 14, 2022
Date of Test: November 7, 2022

Test performed by: **Advanced Packaging Technology Laboratories, Inc.**
200 Larkin Drive, Unit H
Wheeling, IL 60090

Test conducted for: **Veolia North America**
W6490B Specialty Drive
Greenville, WI 54942

Attention: Scott Stewart

Items tested: One (1) sample set of combination packages intended for the transport of hazardous articles.

Box: 32 ECT End-loading FOL style / SW C flute corrugated box

Approximate size (O.D.): 50" L x 9.5" W x 9.375" H

Inner package: One (1) 5.5 mil gusseted poly liner w/ spent 4 ft. T8 fluorescent lamps

See descriptions in body of report.

Nominal tare weight: 3.548 lbs.

Nominal gross weight: 34.7 lbs.

Object of test: Design qualification testing to determine compliance with applicable sections of 49 CFR pertaining to the transport of dangerous goods – Packing Group II.

Findings: As submitted and tested, this package design was considered to comply with noted requirements.



4G / Y15.7 / S / 22*
USA / +BR11903

Not to scale, for example purposes only.

*indicates last two digits of year of manufacture as per 178.503 (a) (6)

Expiration: This package certification expires 2 year(s) from the date of this report.



Kimberly Grumbos
UN/DOT Manager



Rafael Cameron
UN Senior Project Engineer

Table of Contents

Section 1	Cover Page
Section 2	Package Description
Section 3	Testing Procedures and Results
Section 4	Calculations
Section 5	Drawings and Pictures of Packaging Components
Appendix A	Test Equipment and Instrumentation
Appendix B	Definitions / Abbreviations / Conversions

Section 2 - Package Description

Fiberboard Box

Package identification:	UN 4G			
Manufacturer:	Great Northern Corp., Appleton, WI			
Box style:	End-loading FOL	Flute:	C	
Material:	Fiberboard (Kraft) WT	Number of walls:	One (1)	
Caliper:	0.139	in.	Combined weight of facings:	68.28 #/MSF
International box code:	0203			
Part number:	Supply-043			
Box maker's certification:	Mullen burst:	N/A	ECT:	32
Outer dimensions (erected) *see note				
Length	50	in	1270	mm
Width	9.5	in	241.3	mm
Height	9.375	in	238.125	mm
Inner dimensions (erected) *see note				
Length	49	in	1244.6	mm
Width	9.125	in	231.775	mm
Height	9.125	in	231.775	mm
Top flap inner gap	N/A	in	N/A	mm
Top flap outer gap	N/A	in	N/A	mm
Bottom flap inner gap	N/A	in	N/A	mm
Bottom flap outer gap	N/A	in	N/A	mm
Manufacturers joint width:	1.5" outside corner glued			
Gram weight:	833.4 grams			
Quantity:	One (1)			
Board combination indicated:	35-23-35			
Board combination actual:	35.02-23.07C-33.26			
Accessories:	1" x 1" Velcro Tabs: quantity: four (4) - gram weight: 0.8 grams / 8.5" L x 5.5" W Instructions sheet (folded): quantity: one (1) - gram weight: 6.3 grams			
*Note:	Box outer and inner dimensions indicated in this report are of the package assembled and erected.			

Corrugated Perimeter Tube

Manufacturer:	Great Northern Corp., Appleton, WI			
Inner packaging style:	Corrugated perimeter tube	Flute:	B	
Material:	Fiberboard (Kraft)	Number of walls:	One (1)	
Caliper:	0.110 in.	Combined weight of facings:	67.93	#/MSF
Part number:	Supply-043 tube			
Box maker's certification:	Mullen burst:	N/A	ECT:	32
Outer dimensions				
Length	48	in	1219.2	mm
Width	9	in	228.6	mm
Height	9	in	228.6	mm
Inner dimensions				
Length	48	in	1219.2	mm
Width	8.875	in	225.425	mm
Height	8.875	in	225.425	mm
Gram weight:	550.8 grams			
Quantity:	One (1)			
Board combination indicated:	35-23-35			
Board combination actual:	34.93-22.43B-33.0			
Unique features:	1.25" inside corner glued manufacturer's joint			

Inner Packaging (Poly Bag)

Manufacturer:	General Plastics Extrusions, Inc. Prescott, WI			
Inner packaging style:	5.5 mil gusseted tubular style bag			
Material:	LLDPE			
Part number:	Supply-043V(5.5)			
Flat dimensions				
Width	10	in	254	mm
Depth	9.25	in	234.95	mm
Height	63	in	1600.2	mm
Thickness	0.0052	in	0.132	mm
Manufacturing method:	Extruded, heat sealed bottom seam			
Gram weight:	210.4 grams			
Quantity:	One (1)			
Unique features:	None			
Resin manufacturer:	Proprietary			
Resin grade:	Proprietary			
Tensile strength – MD*:	Proprietary	lbs./in ²	(lbf – load at max load)
Tensile strength – CMD*:	Proprietary	lbs./in ²	(lbf – load at max load)
Melt-flow index:	Proprietary	g/10 min.		
Resin density:	Proprietary	g/cm ³		

Closure (Cable-Tie)

Manufacturer:	Giantlok (Thailand) Co., Ltd., 262/10 Moo 3, T. Borwin A. Sriracha Chonburi 20230 Thailand				
Style:	8.5" cable tie				
Part number:	GT – 215I				
Material:	PA66				
Resin manufacturer:	Proprietary				
Resin grade:	Proprietary				
Manufacturing method:	Injection Molded				
Melt-flow index:	Proprietary	g/10 min.			
Resin density:	Proprietary	g/cm ³			
Overall dimensions:	Length:	8.5	in	215.9	mm
	Width:	0.14	in	3.556	mm
	Thickness:	0.047	in	1.193	mm
Locking head dimensions (only):	Length:	0.26	in	6.604	mm
	Width:	0.24	in	6.096	mm
	Height:	0.17	in	4.318	mm
Orientation / Location:	Attached to poly liner				
Application force:	The cable-tie was applied using 10 lbs. of force				
Quantity:	One (1)				
Gram weight:	1.0 grams				

Closing Methods

Sealing method:	Taped
Manufacturer:	Shurtape, Hickory, NC
Part number:	HP200
Type:	3" wide hot melt tape
Size:	2.85" W x 28.25" L
Orientation:	Each end: one (1) continuous strip of tape sealing the three (3) exposed flap edges.
Gram weight:	2.3 grams
Quantity:	Two (2)

Additional Test Information

Overall tare weight of package:	3.548	lbs.	1.609	kg.
Test contents:	Actual product – Spent 4 ft. T8 fluorescent lamps & Fine sand (0.125mm-0.25mm)			
Density	14,150 grams (31.194 lbs.)			
Test weight of package:	34.742	lbs.	15.758	kg.
Authorized package gross weight based on Density:	34.7		lbs.	

Third-Party Laboratory Assembly and Closure Instructions

*Same as Customer or Filler's (End-User's) Assembly and Closure Instructions.

Equipment used to prepare the packages for testing

- Torque tester - Secure-Pak, digital, #D-928
- Tape dispenser - ULINE, 2" wide hand-held, #H-150
- Tape dispenser - ULINE, 3" wide hand-held, #H-596
- Induction sealer - Jores Tech, set @ 80° C, #IND-100HA
- Glue gun - 3M Industrial, set @ 220° F, # 75S9
- Poly bag sealer - Jores Tech, Handheld Bag Sealer, one heat setting, #E-MMS-150CPE
- Paint can sealer, cam action seals plugs by Freund # 7855
- Hand - applied
- Other:
- Other: Chatillon-N.Y.-U.S.A.-Model IN-50 pull force gauge



**Fluorescent Lamp Recycling Box
Instructions and Terms and Conditions**

PROGRAM APPROVED FOR USE IN THE USA ONLY. NOT FOR EXPORT.



WARNING

DO NOT ALTER THIS CONTAINER!

Any alterations to this container will void the Terms and Conditions set forth for the RecyclePak® program. Additionally, your company will be subject to additional fees.

Questions regarding this container should be directed to customer service, toll-free at 1-888-669-9725

PROGRAM APPROVED FOR USE IN THE USA ONLY. NOT FOR EXPORT.

Rev 03/2016

RECYCLEPAK® PACKAGING AND SHIPPING INSTRUCTIONS

THE INSTRUCTIONS MUST BE FOLLOWED FOR SAFE PACKING, STORAGE AND SHIPMENT OF THIS CONTAINER.

Lamp Recycling Boxes (Applies to Supply-043, Supply-044, Supply-065, Supply-098, Supply-126, Supply-190, Supply-191 and Supply-192)

Required Safety Supplies:

Veolia recommends the user of this service to utilize gloves and safety glasses when any kind of hazardous materials.

AUTHORIZED CONTENTS: - The RecyclePak® lamp boxes are designed for a variety of lamp types. Please follow the guidance below as to the types of lamps allowed in RecyclePak® lamp boxes. Placing unauthorized materials inside any RecyclePak® container will subject you to additional handling fees as well as violate our terms and conditions and eliminate any liability protection offered under this program.

- **Supply-043-** Holds 30 T12 / 72 T8 4ft straight fluorescent lamps, misc. 4ft T5 straight lamps, misc. 4ft straight LED lamps and misc. u-tube lamps.* (UN Rated Weight-34 lbs.)
- **Supply-044-** Holds 16 T12 / 39 T8 8ft straight fluorescent lamps, misc. 8ft T5 straight lamps, and misc. 8ft straight LED lamps.* (UN Rated Weight-35 lbs.)
- **Supply-065-** Holds 68 T12 / 146 T8 4ft straight fluorescent lamps, misc. 4ft T5 straight lamps, misc. 4ft straight LED lamps and misc. u-tube lamps.* (UN Rated Weight-66 lbs.)
- **Supply-098-** Holds 16 T12 / 39 T8 4ft straight fluorescent lamps, misc. 4ft T5 straight lamps, and misc. 4ft straight LED lamps.* (UN Rated Weight-17 lbs.)
- **Supply-126-** Holds 22 T12 / 32 T8 u-tube lamps, misc. amounts of high intensity discharge lamps, up to 250 compact fluorescent lamps or small LED lamps.* (UN Rated Weight-58 lbs.)
- **Supply-190-** Holds 25 T12 / 57 T8 8ft straight fluorescent lamps, misc. 8ft T5 straight lamps, and misc. 8ft straight LED lamps.* (UN Rated Weight-61 lbs.)
- **Supply-191-** Holds 46 T12 / 81 T8 u-tube lamps, and up to 60 400W HID.* (UN Rated Weight-54 lbs.)
- **Supply-192-** Holds 150 small spiral compact fluorescent lamps, 525 2-pin compact fluorescent lamps, 265 4-pin compact fluorescent lamps, misc. incandescent and LED lamps.* (UN Rated Weight-37 lbs.)

***DO NOT EXCEED THE UN RATED WEIGHT WHEN PLACING LAMPS IN CONTAINER.**

ADDITIONAL RESTRICTIONS: Customers in the District of Columbia must have obtained an EPA ID number from the District Department of the Environment (DDOE) and comply with additional reporting requirements contained within the DDOE rules.

Step #1 – Locate and Complete Prepaid Return Shipping Label Booklet

1. Open your FedEx Ground Label booklet adhered to the front of the box by removing the "remove to open" tab. (See Figure 1). Detach to expose label. Retain your proof of purchase included within the FedEx Ground Label booklet. Since certain states require special handling (Alaska, Hawaii and Puerto Rico), a prepaid shipping label may not be enclosed. Please contact customer service toll-free at 1-888-669-9725 to arrange for pickup if a label was not enclosed.
2. Write your mailing address in the "From" section on the FedEx Ground label (See Figure 2). Make sure to include your company name, mailing address, city, state and zip code. A CERTIFICATE OF RECYCLING WILL NOT BE ISSUED IF THIS IS NOT COMPLETELY FILLED OUT.
3. Complete the label by checking the type of material you will be placing in the container and entering an "ACCUMULATION START DATE". The "ACCUMULATION START DATE" is defined as the date when your first lamp was placed into the RecyclePak® (See Figure 3).
4. Enter the "ACCUMULATION START DATE" also on the container under the "GENERATORS RESPONSIBILITIES" (See Figure 4).
5. Apply the appropriate color coded sticker to the FedEx Ground label as directed in your FedEx Ground Label booklet and map (See Figure 5). If you have questions, please call customer service toll-free at 1-888-669-9725. SHIPPING TO UNAUTHORIZED ZONES will subject you to additional handling charges.

Step #2 – Prepare Package

1. Open container, close bottom flaps in order marked and seal bottom of box with 3" minimum 2 mil clear plastic tape (Shurtape HP200) or equivalent. MAKE SURE CORNERS, EDGES, FLAPS AND SEAMS ARE PROPERLY SEALED WITH TAPE (See Figure 6). FOR FULL OVERLAP FLAPS (FLAPS THAT ARE THE SAME WIDTH AND LENGTH OF THE CARTON), SEAL ALL FOUR SIDES OF THE FLAPS. FOR RSC FLAPS (FLAPS THAT MEET IN THE MIDDLE), TAPE FLAPS USING A "H" PATTERN.

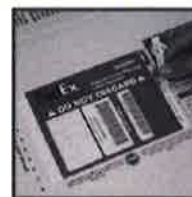

Figure 1



Figure 2



Figure 3



Figure 4



Figure 5



Figure 6

Customer Service | Toll Free: 1-888-669-9725 Monday-Friday – 8am to 5pm CST
LAMPS RECYCLING BOXES | REV 03/2016





PLACING THE BROWN CORRUGATED TUBE INSIDE THE LINER IS REQUIRED. DO NOT PLACE THE LINER INSIDE THE RECYCLEPAK® WITHOUT FIRST PLACING THE BROWN CORRUGATED TUBE INSIDE THE LINER. FAILURE TO DO THIS WILL RESULT IN NON-COMPLIANT SHIPPING AND SUBJECT YOU TO ADDITIONAL HANDLING FEES.

2. Open brown corrugated tube and place inside the liner (See Figure 7). Place bagged tube into RecyclePak® (See Figure 8).
3. Locate (4) enclosed white Velcro strips, remove backing from both sides and apply to the top flaps marked "EZ" on the RecyclePak® (See Figure 9). Close flaps in order marked. Press firmly to secure temporary Velcro seal on both sides. Open flap carefully to ensure Velcro is adhered to both the top and backside of the flap. Prepare to fill.



Figure 7



Figure 8

Step #3 – Fill Container

1. Carefully fill the RecyclePak® with appropriate number of lamps. This depends upon the model box purchased. Refer to AUTHORIZED CONTENTS above for guidance. DO NOT BREAK OR CRUSH LAMPS. USE WHOLE OR INTACT LAMPS ONLY (See Figure 10).
2. High Intensity Discharge Lamps (HIDs) must be placed into original manufacturer boxes OR wrapped in newspaper prior to being placed into RecyclePak®.
3. DO NOT EXCEED CAPACITY. AN ADDITIONAL SERVICE FEE WILL APPLY TO ALL ITEMS RECEIVED THAT EXCEED THE PUBLISHED CAPACITY.
4. KEEP BOX AND LINER CLOSED WHEN NOT IN USE.



Figure 9

Step #4 – Seal Container

1. When the RecyclePak® is full and lamps are packed tightly, seal poly liner by twisting and securing with the provided 8" 40 lb. PA66 cable tie (Giantlok GT – 2151 Cable tie). Make sure poly liner is sealed and completely within box.
2. Close box flaps or cover in order as stated on packaging and seal with minimum 3" wide clear 2 mil plastic tape (Shurtape HP200) or equivalent (See Figure 6). MAKE SURE CORNERS, EDGES, FLAPS AND SEAMS ARE PROPERLY SEALED WITH TAPE. FOR FULL OVERLAP FLAPS (FLAPS THAT ARE THE SAME WIDTH AND LENGTH OF THE CARTON), SEAL ALL FOUR SIDES OF THE FLAPS. FOR RSC FLAPS (FLAPS THAT MEET IN THE MIDDLE), TAPE FLAPS USING A "H" PATTERN. The RecyclePak® container MUST BE PROPERLY SEALED AND STRUCTURALLY SOUND. THE CONTAINER MUST LACK EVIDENCE OF LEAKAGE OR DAMAGE THAT COULD CAUSE LEAKAGE. FedEx Ground may refuse packages that do not meet these criteria!



Figure 10

Step #5 – Ship Container

1. Complete the GENERATORS RESPONSIBILITIES section on the container to include the TYPES and COUNTS of waste materials inside the container. (See Figure 11).



Figure 11

Step #6 – Arranging for Pick Up

1. For business customers, call FEDEX® GROUND® (800) GO-FEDEX (463-3339) to schedule a GROUND RETURN pickup. Say "PRP" when prompted by the auto attendant. Alternatively, you can schedule a pickup online at www.fedex.com/returnpickup
2. The RECYCLEPAK® container MUST BE PROPERLY SEALED AND STRUCTURALLY SOUND. THE CONTAINER MUST LACK EVIDENCE OF LEAKAGE OR DAMAGE THAT COULD CAUSE LEAKAGE. FEDEX® GROUND® may refuse packages that do not meet the criteria!
3. Since certain states require special handling (Alaska, Hawaii and Puerto Rico), a prepaid shipping label may not be enclosed. Please contact customer service toll-free at 1-888-669-9725 to arrange for pickup if a label was not enclosed.
4. Keep a copy of your Proof of Purchase card, which includes your Unique Container number and FedEx Ground tracking (See Figure 12).



Figure 12

Additional Shipping Charges

If you exceed the stated capacity of a RECYCLEPAK® container, ship us non-approved contents, ship us items in the wrong RECYCLEPAK® container, ship us items in a container other than an approved RECYCLEPAK® container, we can charge you an additional fee to compensate us.



ATTENTION: CUSTOMERS IN THE DISTRICT OF COLUMBIA MUST HAVE OBTAINED AN EPA ID NUMBER FROM THE DISTRICT DEPARTMENT OF THE ENVIRONMENT (DDOE) AND COMPLY WITH ADDITIONAL REPORTING REQUIREMENTS AS CONTAINED IN THE DDOE RULES.



ATTENTION: CUSTOMERS IN THE STATE OF MAINE MUST CALL CUSTOMER SERVICE TOLL-FREE AT 1-888-669-9725 PRIOR TO SHIPPING THIS CONTAINER. ADDITIONAL LABELING REQUIRED.

Customer Service | Toll Free: 1-888-669-9725 Monday-Friday – 8am to 5pm CST
LAMPS RECYCLING BOXES | REV 03/2016



RECYCLEPAK® CONTAINER TERMS AND CONDITIONS

USE OF THE RECYCLEPAK® CONTAINER OR SERVICE IS CONSIDERED ACCEPTANCE OF THE TERMS AND CONDITIONS.

Thank you for choosing the RECYCLEPAK® container service for the proper handling, return transportation and recycling of your lamps, ballasts, batteries, mercury devices, dental wastes, cell phones, inkjet cartridges and electronics (The word "MATERIALS" is used herein to describe the wastes). Each RECYCLEPAK® container is compatible for specific MATERIALS. Please check your RECYCLEPAK® container to verify the container is suitable for shipping your specific waste. In order to serve you better, we have prepared these Terms and Conditions to set forth your and our rights and obligations. Please understand that, by using RECYCLEPAK® containers, you are agreeing to these Terms and Conditions.

Refunds- If you purchased your RECYCLEPAK® online at www.prepaidrecycling.com or any of our manufacturing partner web sites and do not agree with these Terms and Conditions please call us, within 15 days, toll-free at (888) 669-9725 for return instructions. We will make every effort to send you a refund following receipt of the unused RECYCLEPAK® containers. To be eligible for a refund, you must provide a proof of purchase, so please retain your receipt showing the purchase price and date. If you purchased your RECYCLEPAK® from a distributor or third-party, please contact the distributor or third-party directly to request a refund.

Our Promise- We promise that our RECYCLEPAK® containers, provided they have not been damaged and have been properly packed and sealed in accordance with our instructions, with contents limited to only the MATERIALS described above, in containers required for specific MATERIALS described above, are suitable for shipping those MATERIALS. (If a prepaid shipping label was provided to you with the container, please use it to ship your MATERIALS to us. If you did not receive a prepaid shipping label, you are located in a state or jurisdiction that does not allow their use. In this case, please contact Veolia toll-free at (888) 669-9725 to arrange for shipping). In accordance with 40 CFR 264.12(b), 273.18(d) and 273.38(d), we have the appropriate permits and agree to receive the MATERIALS, as described on the RECYCLEPAK® label and packaging instructions. We also promise that we will properly manage, recycle and dispose of the enclosed MATERIALS in accordance with the law, provided that we receive the RECYCLEPAK® container within 18 months of purchase date. If you abide by your promise as stated below, we agree to take title, and all other incidents of ownership, to your MATERIALS at the time that the RECYCLEPAK® container(s) is received by our transporter. If, for any reason, our carrier as identified on the prepaid return label will not ship the RecyclePak® container, we will work with you to identify alternative shipping. We will refund the actual shipping charges received by us from you if similarly priced alternative shipping cannot be located.

Your Promise- You promise that you will send us only the MATERIALS described above, in undamaged RECYCLEPAK® containers packaged in accordance with our instructions, in a quantity that does not exceed the stated capacity of the containers and in RECYCLEPAK® containers required for specific MATERIALS. If included, you promise to properly fill out the prepaid shipping label (name, address, city, state or province, zip or postal code) and affix where stated to the container. Furthermore, you promise not to place the prepaid shipping label on any pail, box or drum other than the RECYCLEPAK®, and if required by the RECYCLEPAK® container, you certify that you qualify as either a conditionally exempt very small quantity generator or a conditionally exempt small quantity generator, as defined by US EPA regulations 40 CFR 261.5 or are otherwise exempt from hazardous waste manifesting requirements in accordance with applicable state regulations.

Please understand that your failure to keep your promise may result in bodily injuries (including death), property damage, contamination of or adverse effects on the environment and/or violation of applicable laws or regulations and may also result in our seeking indemnification from you under the Indemnification section below. Legal action, suits, claims, costs and expenses incidental thereto, in addition to government-assessed fines and penalties could occur in connection with your failure to keep your promise.

Additional Charges and Return of Materials - So we can serve you better, please be sure to use only RECYCLEPAK® containers for sending us only the MATERIALS described above and to use them in accordance with our instructions. If you exceed the stated capacity of a RECYCLEPAK® container, we reserve the right to charge you an additional fee to compensate us for the extra MATERIALS. In the event you fail to abide by our instructions and you ship us MATERIALS in containers other than RECYCLEPAK®, ship us MATERIALS in a RECYCLEPAK® container that is inappropriate for those MATERIALS, ship us containers from restricted states or countries, or ship us wastes that are not MATERIALS as described above (The word "NON-CONFORMING CONTAINER" is used herein to describe these shipments), we will charge you and you agree to pay additional fees within 30 days of invoice. We will charge you an ADDITIONAL SHIPPING AND HANDLING FEE of \$75.00 for each NON-CONFORMING CONTAINER shipped to reimburse us for the added costs in dealing with the NON-CONFORMING CONTAINER. If you send us a NON-CONFORMING CONTAINER, we will try to manage its contents, if possible, but we will charge you for any extra costs in addition to the ADDITIONAL SHIPPING AND HANDLING FEE listed above. Those costs shall be based on the retail rate for a RECYCLEPAK of similar size as published at www.prepaidrecycling.com at the time we receive the NON-CONFORMING CONTAINER. In the event you send us wastes that are not MATERIALS and we are unable, for any reason, to manage them you agree we can return the wastes that are not MATERIALS to you at your expense and you also agree to still pay us the ADDITIONAL SHIPPING AND HANDLING FEE above.

DISCLAIMER - IN NO EVENT SHALL WE BE RESPONSIBLE TO YOU FOR CONSEQUENTIAL, INCIDENTAL, INDIRECT, SPECIAL OR PUNITIVE DAMAGES IN CONNECTION WITH THESE TERMS AND CONDITIONS OR YOUR USE OF RECYCLEPAK® CONTAINERS, WHETHER BASED IN CONTRACT, TORT, STRICT LIABILITY, STATUTE OR OTHERWISE.

Indemnification

- A. We promise to indemnify you (which includes your employees, officers and directors) from any and all liability and claims (including costs of defense, settlement and reasonable attorneys' fees) which you may incur as the result of bodily injuries (including death), property, contamination of the environment or any violation of law to the extent caused by (1) our breach of these Terms and Conditions (including, but not limited to, the Our Promise section above) or (2) our or our employees', officers' or directors' negligence or willfulness which occurs during our providing services to you, as long as you have sent us wastes that are MATERIALS as described above.
- B. You promise to indemnify us (which includes our employees, officers and directors) from any and all liability and claims (including costs of defense, settlement, and reasonable attorneys' fees) which we may incur as the result of bodily injury (including death), property damage, contamination of the environment or any violation of law to the extent caused by (1) your breach of these Terms and Conditions (including, but not limited to, the Your Promise section above) or (2) you or your employees', officers' or directors' negligence or willfulness which occurs during your seeking or obtaining services from us.

Customer Service | Toll Free: 1-888-669-9725 Monday-Friday – 8am to 5pm CST
LAMPS RECYCLING BOXES | REV 03/2016



Section 3 – Testing Procedures and Results

Package Preparation – For All Testing

The packages were filled to a minimum of 95% full (see Section 4 for calculation). The inner packaging was inserted as described in the closure instructions.

Package Panel Orientation – For All Test setups

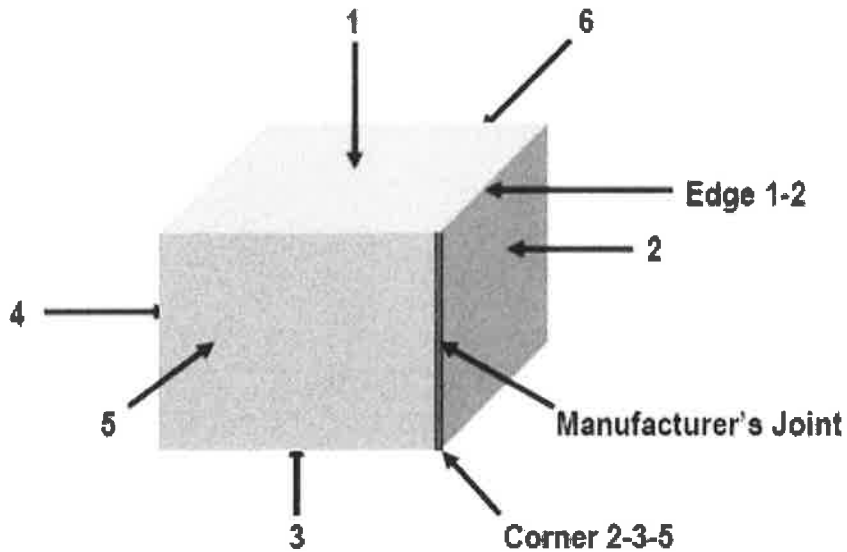

Drop Test

Test Method: 49 CFR 178.603

Number of packages tested:	Five (5)	
Drop height:	1.2	meters

(Calculation for the drop height is provided in Section 4)

Testing was conducted to certify the package for Packing Group:	II	
Actual product – Spent 4 ft. T8 fluorescent lamps & Fine sand (0.125mm-0.25mm)	34.7	lbs.

Conditioning

The packages were conditioned to 50% +/- 2% relative humidity at 23 °C +/- 2 °C in accordance with 49 CFR178.602, 178.603(c). The packages were conditioned for at least 24 hours to ensure the package and contents were at the proper temperature prior to testing. Drop testing was conducted approximately 2 minutes after removing the test package from the conditioning chamber. The temperature of the test media was checked during the inspection process.

Results

Box Number	Package Weight		Orientation	Results & Description
1	34.742	Lbs.	Flat on Bottom-Face 3	Pass / No visible damage or leakage. No change in appearance, looks like new.
2	34.742	Lbs.	Flat on Top-Face 1	Pass / No visible damage or leakage. No change in appearance, looks like new.
3	34.742	Lbs.	Flat on Long Side-Face 2	Pass / On impact, package imploded but there was no leakage.
4	34.742	Lbs.	Flat on Short Side-Face 5	Pass / On impact, package imploded but there was no leakage.
5	34.742	Lbs.	Mfg. Corner-Corner 1-5-2	Pass / No leakage. Corner crushed 1/2".

Pass/Fail Criteria

A package is considered to successfully pass the drop tests if for each sample tested: There is no damage to the outer packaging likely to adversely affect safety during transport, there is no leakage of the filling substance from the inner packaging and any discharge from a closure is slight and ceases immediately after impact. After the test was completed, the test samples were opened and inspected for any damage; samples were placed horizontally during inspection to check for any leaks, spillage, or loss of contents (duration of five minutes minimum).

Stacking Test

Test Method: 49 CFR 178.606

Free standing: <input checked="" type="checkbox"/>	Group stack: <input type="checkbox"/>	Individual stack: <input checked="" type="checkbox"/>
Packages tested: Three (3)	Test duration: 24	hours

Group stack description: Not used.

The packages were conditioned in accordance with 49 CFR 178.602(d) to 50% +/- 2% relative humidity at 23 °C +/- 2 °C for at least 24 hours.

Stacking test weight:	450.00	lbs.	204.118	kg
Rounded up from:	402.52	lbs.	182.581	kg

See Section 4 for Calculation.

The stacking test load was applied to the top of the packages by loading each package with the stacking test weight (above) and the weight was maintained for 24 hours.

Results

Package #	Pass / Fail	Description of Results
6	Pass	No damage or leakage. No change in appearance, looks like new.
7	Pass	No damage or leakage. No change in appearance, looks like new.
8	Pass	No damage or leakage. No change in appearance, looks like new.

Note: Stacking stability was not assessed since a guided load test was not performed.

Pass/Fail Criteria

No test sample may leak. There must be no leakage of the filling substance from the inner receptacle, or inner packaging. No test sample may show any deterioration which could adversely affect transportation safety or any distortion likely to reduce its strength, cause instability in stacks of packages, or cause damage to inner packaging's likely to reduce safety in transportation. After the test was completed, the test samples were opened and inspected for any damage; samples were placed horizontally during inspection to check for any leaks, spillage, or loss of contents (duration of five minutes minimum).

Package was used from previous test? Yes or No:

Package #	No	Not applicable.
Package #	No	Not applicable.
Package #	No	Not applicable.

Vibration Standard

Test Method: 49 CFR 178.608 using ASTM 999-08 (Method A1)

Test contents of inner containers:	Actual product – Spent 4 ft. T8 fluorescent lamps & Fine sand (0.125mm-0.25mm)
Number of packages tested:	Three (3)

The packages were conditioned in accordance with 49 CFR 178.602(d) to 50% +/- 2% relative humidity at 23 °C +/- 2 °C for at least 24 hours. The samples were placed on the table and the steel shim (2" wide x 10" long by 1/16" thick, steel) was used (inserted a minimum of 4" under the test sample and along the full length of the box on all sides) to assist in adjusting the frequency.

Duration:	1 hour			
Frequency:	4.4	Hz	264	rpm

Results

Package #	Pass / Fail	Description of Results
9	Pass	No damage or leakage. Slight scuffing on bottom of package.
10	Pass	No damage or leakage. Slight scuffing on bottom of package.
11	Pass	No damage or leakage. Slight scuffing on bottom of package.

Note: Packages were vibrated in a group of three (3).

Pass/Fail Criteria

A packaging passes the vibration test if there is no rupture or leakage from any of the packages. No test sample should show any deterioration which could adversely affect transportation safety or any distortion liable to reduce packaging strength. After the test was completed, the test samples were opened and inspected for any damage; samples were placed horizontally during inspection to check for any leaks, spillage, or loss of contents (duration five minutes minimum).

Package was used from previous test. Yes or No:

Package #	No	Not applicable
Package #	No	Not applicable
Package #	No	Not applicable

Cobb Test

Test Method: ISO International Standard 535 as required by 49 CFR 178.516(b) (1)

The packages were conditioned in accordance with 49 CFR 178.602(d) to 50% +/- 2% relative humidity at 23 °C +/- 2 °C for at least 24 hours. Five (5) samples were tested from the boxes and subjected to a water absorption test in accordance with ISO International Standard 535.

Results

Sample Number	Water Absorption		Pass / Fail
1	150	g/m ²	Pass
2	147	g/m ²	Pass
3	148	g/m ²	Pass
4	151	g/m ²	Pass
5	152	g/m ²	Pass
Average	149.6	g/m ²	Pass

Pass/Fail Criteria

An increase in mass of greater than 155 g/m² over the 30 minute duration of the test represents an unacceptable level of water resistance.

Section 4 - Calculations

Capacity

Capacity of container:	N/A	Gallons	N/A	Liters
------------------------	-----	---------	-----	--------

Empty Package Weight

Outer Packaging:	833.4	grams	0.833	kg	1.837	lbs.
Intermediate packaging:	560.3	grams	0.56	kg	1.235	lbs.
Inner packaging:	211.4	grams	0.211	kg	0.466	lbs.
Outer Packaging Closures:	4.6	grams	0.004	kg	0.01	lbs.
Total:	1609.7	grams	1.609	kg	3.548	lbs.

Filled Package Weight

Test product weight (100% full):	31.194	lbs.	14.149	kg
Test package gross weight:	34.742	lbs.	15.758	kg

Drop Test Height

Specific gravity of certification <input checked="" type="checkbox"/> Not adjusted for specific gravity*	Actual product – Spent 4 ft. T8 fluorescent lamps & Fine sand (0.125mm-0.25mm)		
Packing group of certification	II		
Drop height: specific gravity x N/A =	1.2	meters	

* Drop height based on actual product/weight.

Marked Weight to Accommodate Actual Product

Weight of fill	31.194	lbs.	14.149	kg
Total tare weight	3.548	lbs.	1.609	kg
Weight of fill + Tare weight	34.742	lbs.	15.758	kg
Marked weight rounded down	34.7	lbs.	15.7	kg

Certified Weights

Certified actual product weight	31.194	lbs.	14.149	kg
Certified product weight + Tare weight	34.742	lbs.	15.758	kg
Certified gross weight (rounded down)	34.7	lbs.	15.7	kg

Stack Test Weight

Load = (n-1) [W+Q (L x S)]

Where:

N = Number of containers to reach 3 meters

W = Tare weight of all packaging material

Q = Quantity of inner packages

L = Weight of liquid fill

S = Maximum specific gravity

Actual product

Stacking height	9.375	inches	=	23.81	cm
Stack height = 3.0 meters = 118.11 inches	118.11	/	9.375	=	12.6 Boxes high
Stack height - 1 x marked weight (above)		11.6	x	34.7	lbs.
= Calculated stack weight	402.52	lbs.		182.58	kg
= Actual stack weight	450	lbs.		204.11	kg

Section 5 - Drawings and Pictures of Packaging Components

Pictures



Fiberboard Box

Great Northern Corporation				SPEC CARD			
CUSTOMER		ITEM NUMBER OR DESCRIPTION		D/B NO.		FILE NUMBER	
Veolia ES Technical Solutions		Supply-043		J D/C P		169974	
L	W	D	COATING	AREA MINUS HOLES	JOINT	ACETATE	REV
9'02"	X 9'02"	X 49"	None	2563.89	GL OUT		
PRINTING	FINISHED SIZE	NO OUT	SHEET SIZE	IN. RULE	SETUP BY	DATE	
4P2C	38'08" x 67'14"		39'08" x 68'14"	590.95	Gloede	10/12/2016	
FINISHING INSTRUCTIONS							
LINER COMBINATION 35-23-35 HAZ MAT ITEM							
HARR CORR D/B IS CUSTOMER SUPPLIED							
OUTSIDE GLUE !!!							
MACHINE ROUTING							
1. TOTAL RULE							
2. SCRAP AREA (%)							
3. WEIGHT							
4.							
5.							
6.							
NOTE: DIMENSIONS ARE STATED / WHOLE NUMBER / SIXTEENTHS							

INSIDE VIEW
CUT ON SOLID LINE;
SCORE ON BROKEN LINE:

Inner Packaging (Poly liner)



General Plastic Extrusions, Inc.

1248 Kesson Drive, Prescott, WI 54021 Phone: (715) 262-4806
 www.generalplastic.com FAX: (715) 262-8836

Product: 9.75x9.75x63x5.5 Mil POR Gus Bag

Item #: PGB-17034MNN-3003

Product Properties:

PROPERTY	
Nominal Thickness (mil)	5.5
Yield (lb*20lb)	5,000
Color	Clear
Count/Package	75
Package Weight (lbs)	38.42

Dimensional Specifications:

PROPERTY	Target	Minimum	Maximum
Product Width (in)	9.75	9.5	10
Gusset Width (in)	9.75		
Total Width (in)	19.5	19.25	19.75
Product Length (in)	63	62.75	63.25

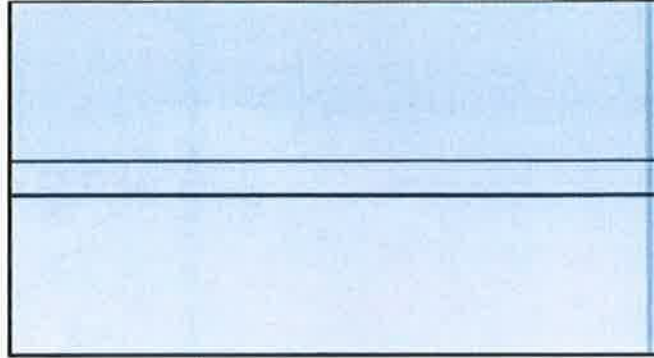

Drawing NOT to Scale

GIANTLOK (THAILAND) CO.,LTD.

STANDARD DRAWING	GT - 215 I				หน้า
SD-QC-092	ผู้จัดทำ	ผู้ตรวจสอบ	ผู้อนุมัติ	วันที่ประกาศใช้	หน้า
	W. S. S. S.	W. S. S. S.	W. S. S. S.	15/12/2012	Rev.00

CABLE TIES

NOTE:

- 1) CABLE TIES: GT-215I (215 X 3.6mm)
- 2) Tensile Strength \geq 18.2(40) Kg/lbs
- 3) Max. Bundle Dia: ϕ 57(2.25) mm/inch
- 4) Material: PA66.
- 5) Class: V0,UV,Heat Resistant,Color are available.

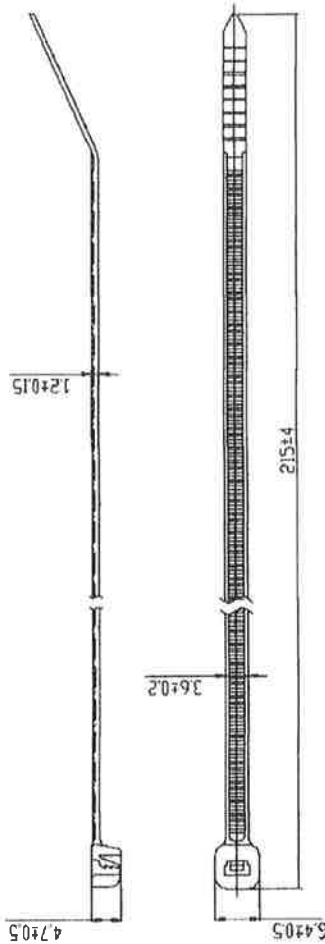
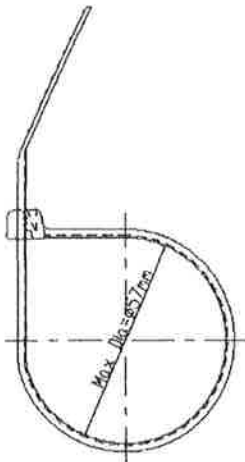

CONTROLLED

Effective Date : 14/11/55

FM - DC - 019 / Rev.02

Shurtape®

1712 8th Street Drive SE
 Hickory, NC 28602 USA
 Phone: (828) 322-2700

HP 200

Production Grade Hot Melt
 BOPP Film Packaging Tape

TYPICAL APPLICATIONS

- > For manual (hand rolls) or automatic (machine rolls) case sealing
- > Recommended for medium weight cartons in normal manufacturing and shipping environments
- > Packaging, bundling, repairing cartons and paper and film bags

COLOR(S)

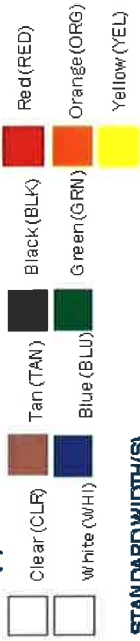

STANDARD WIDTH(S)

48 in/m 72 mm

STANDARD LENGTH(S)

100 m 9.14 m 137.1 m 182.8 m

PHYSICAL PROPERTIES

	STANDARD	METRIC
Thickness	1.9 mils	0.05 mm
Tensile Strength (longitudinal direction)	27 lbs/in width	47.3 N/10 mm
Tensile Strength (transverse direction)	44 lbs/in width	77 N/10 mm
Elongation	150 %	150 %
Adhesion to Stainless Steel	44 oz/in width	4.82 N/10 mm
Holding Power to Fiberboard	15,000 + minutes	15,000+ minutes
Adhesion to Backing - Hand Rolls Only	18 oz/in width	1.97 N/10 mm
Adhesion to Backing - Machine Rolls Only	4 oz/in width	0.44 N/10 mm
Service Temperature Range	20 F to 150 F	-7 C to 66 C
Application Temperature Range	35 F to 110 F	2 C to 43 C

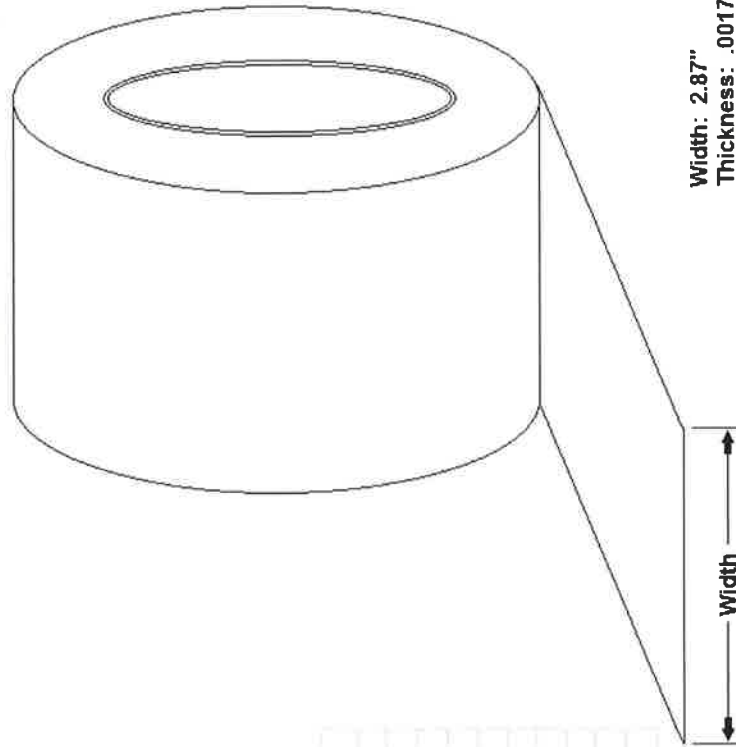

Width: 2.87"
 Thickness: .0017"

Appendix A - Test Equipment and Instrumentation

Instrument or Equipment	Manufacturer	Model Number	Serial Number
Drop Tester	LAB	AD500-48	291045
Gram Scale	Mettler Toledo	PG4002-S	1122253714
Electronic Scale	American Scientific Products	TL-1600S	19538
Pressure Gauge	Cal Labs	0-30psi	BFG-01
Vibration Table	LAB	1250SVMC	8120128
Burst Tester	Perkins-Mullen	1000	12293
Compression Tester	Tinius-Olsen	Electromatic	62560
Torque Tester	Secure-Pak	Digital	D-928
Digital Micrometer	Mitutoyo	Digimatic	29376130
Mechanical Micrometer	Mitutoyo	MIC	LFM-1
Puncture Tester	TMI	A942	A942
Conditioning Chamber #2	Midwest Labs	922A	55455
Conditioning Chamber #6	Thermotron	SM-16C	23409
Conditioning Chamber #12	Thermotron	SM-16C	23408
Conditioning Chamber #16	Thermotron	SM-32C	42371

Calibration reports, certifications or additional information available upon request.

Appendix B - Definitions / Abbreviations / Conversions

Definitions

Proprietary – Customer was unable to obtain the required data or the MFG refused to provide this data due to trade secrets.

Types of Fiberboard: Single-wall (**SW**), Double-wall (**DW**), Triple-wall (**TW**)

Abbreviations

MD-Machine direction

CMD-Cross direction

N/A-Not applicable

N/T-Not tested

N/I-Not indicated

DNA-Does not apply

MSF-1000 square feet

B/A-Board analysis

Conversions

1 gallon water = 8.344 lbs.

1 mm = 25.4 inches

1 kg. = 2.2046 lbs.

1 ounce = 28.349 grams

meters³ = 0.028 ft³

1 fl. Oz. = 29.573 cc

mils = inches / 0.001

1 meters = 39.369 inches

1 meters = 3.28 feet

1 lbs. = 453.6 grams

1 gal = 3.785 liters